

Tavola Mendeleev

Row	Group I — R ₂ O	Group II — RO	Group III — R ₂ O ₃	Group IV RH ₄ RO ₂	Group V RH ₃ R ₂ O ₅	Group VI RH ₂ RO ₃	Group VII RH R ₂ O ₇	Group VIII — RO ₄
1	H = 1							
2	Li = 7	Be = 9.4	B = 11	C = 12	N = 14	O = 16	F = 19	
3	Na = 23	Mg = 24	Al = 27.3	Si = 28	P = 31	S = 32	Cl = 35.5	
4	K = 39	Ca = 40	___ = 44	Ti = 48	V = 51	Cr = 52	Mn = 55	Fe = 56, Co = 59, Ni = 59, Cu = 63
5	(Cu = 63)	Zn = 65	___ = 68	___ = 72	As = 75	Se = 78	Br = 80	
6	Rb = 83	Sr = 87	?Yt = 88	Zr = 90	Nb = 94	Mo = 96	___ = 100	Ru = 104, Rh = 104, Pd = 106, Ag = 108
7	(Ag = 108)	Cd = 112	In = 113	Sn = 118	Sb = 122	Te = 125	I = 127	
8	Cs = 133	Ba = 137	?Di = 138	?Ce = 140				
9								
10			?Er = 178	?La = 180	Ta = 182	W = 184		Os = 195, Ir = 197, Pt = 198, Au = 199
11	(Au = 199)	Hg = 200	Tl = 204	Pb = 207	Bi = 208			
12				Th = 231		U = 240		

Quando gli elementi vengono riportati secondo un ordine di peso atomico crescente, le proprietà degli elementi si ripetono ad intervalli regolari

Gruppo I A → Metalli Alcalini
 Gruppo II A → Metalli Alcalini-Terrosi
 Gruppo IIV A → Alogeni
 Gruppo 0 → Gas Nobili

Caratteristiche Fisiche

Metalli → Lucidi, duttili, malleabili, condutt. elettrici

Semimetalli → intermedie tra Metalli e non metalli

non-metalli → Non Lucidi, fragili, isolanti elettrici

nero = **solido**

blu = **liquido**

rosso = **gas**

IA		IIA												IIIA	IVA	VA	VIA	VIIA	0												
1	IIIB																IVB					VB	VIB	VIIB	VIII B			IB	IIB	2	
Gruppo A – elementi principali																				Gruppi B - elementi di transizione 'd'											
3	4											5	6	7	8	9	10														
11	12											13	14	15	16	17	18														
19	20	21											22	23	24	25	26	27	28	29	30	31	32	33	34	35	36				
37	38	39	serie dei 'lantanidi'										40	41	42	43	44	45	46	47	48	49	50	51	52	53	54				
55	56	57	58	59	60	61	62	63	64	65	66	67	68	69	70	71	72	73	74	75	76	77	78	79	80	81	82	83	84	85	86
87	88	89	90	91	92	93	94	95	96	97	98	99	100	101	102	103	104	105	106	serie dei 'attinidi'											

Gruppo A – elementi principali

Gruppi B - elementi di transizione 'd'

IA		IIA																		IIIA	IVA	VA	VIA	VIIA	VIIIA	0							
1	IIIB																		IVB	VB	VIB	VIIB	VIIIB	IIB				2					
3	4																	5	6	7	8	9	10										
11	12																	13	14	15	16	17	18										
19	20	21																	22	23	24	25	26	27	28	29	30	31	32	33	34	35	36
37	38	39	serie dei 'lantanidi'																40	41	42	43	44	45	46	47	48	49	50	51	52	53	54
55	56	57	58	59	60	61	62	63	64	65	66	67	68	69	70	71	72	73	74	75	76	77	78	79	80	81	82	83	84	85	86		
87	88	89	90	91	92	93	94	95	96	97	98	99	100	101	102	103	104	105	106														
serie dei 'attinidi'																																	

1 H 1.01																	18 He 4.00											
3 Li 6.94	4 Be 9.01											7 N 14.01	8 O 15.99	9 F 19.00	10 Ne 20.18													
11 Na 22.99	12 Mg 25.31	3	4	5	6	7	8	9	10	11 Al 26.98	12 Si 28.09	13 P 30.97	14 S 32.07	15 Cl 35.45	16 Ar 39.95													
19 K 39.10	20 Ca 40.08	21 Sc 44.96	22 Ti 47.87	23 V 50.94	24 Cr 52.00	25 Mn 54.94	26 Fe 55.85	27 Co 58.93	28 Ni 58.71	29 Cu 63.55	30 Zn 65.41	31 Ga 69.72	32 Ge 72.64	33 As 74.92	34 Se 78.96	35 Br 79.90	36 Kr 83.80											
37 Rb 85.47	38 Sr 87.62	39 Y 88.91	40 Zr 91.22	41 Nb 92.91	42 Mo 95.94	43 Tc 98.91	44 Ru 101.07	45 Rh 102.91	46 Pd 106.42	47 Ag 107.87	48 Cd 112.41	49 In 114.82	50 Sn 118.71	51 Sb 121.76	52 Te 127.60	53 I 126.90	54 Xe 131.29											
55 Cs 132.91	56 Ba 137.33	57 La 138.91	72 Hf 178.49	73 Ta 180.95	74 W 183.84	75 Re 186.21	76 Os 190.23	77 Ir 192.22	78 Pt 195.08	79 Au 196.97	80 Hg 200.59	81 Tl 204.38	82 Pb 207.2	83 Bi 208.98	84 Po (209)	85 At (210)	86 Rn (222)											
104 Rf (261)	105 Db (262)	106 Sg (266)	107 Bh (264)	108 Hs (277)	109 Mt (268)	110 Ds (281)	111 Rg (272)										112 Cn (285)	113 Nh (284)	114 Fl (289)	115 Mc (288)	116 Lv (293)	117 Ts (294)	118 Og (294)					
58 Ce 140.12	59 Pr 140.91	60 Nd 144.24	61 Pm (145)	62 Sm 150.36	63 Eu 151.97	64 Gd 157.25	65 Tb 158.93	66 Dy 162.50	67 Ho 164.93	68 Er 167.26	69 Tm 168.93	70 Yb 173.04	71 Lu 174.97	72 Hf 178.49	73 Ta 180.95	74 W 183.84	75 Re 186.21	76 Os 190.23	77 Ir 192.22	78 Pt 195.08	79 Au 196.97	80 Hg 200.59	81 Tl 204.38	82 Pb 207.2	83 Bi 208.98	84 Po (209)	85 At (210)	86 Rn (222)
90 Th 232.04	91 Pa 231.04	92 U 238.03	93 Np (237)	94 Pu (244)	95 Am (243)	96 Cm (247)	97 Bk (247)	98 Cf (251)	99 Es (252)	100 Fm (257)	101 Md (258)	102 No (259)	103 Lr (262)															

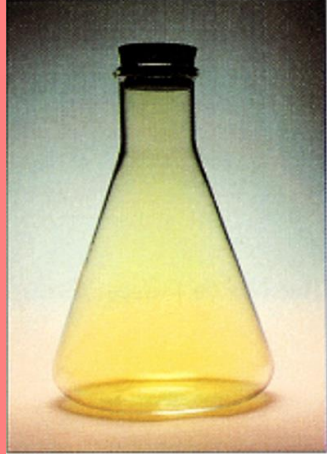

$$\lambda \cdot \nu = c$$

$$\nu = \frac{c}{\lambda}$$

c = velocità di propagazione
nel vuoto = $3 \cdot 10^8$ m/s

λ = lunghezza d'onda [cm]

ν = frequenza [1/s]

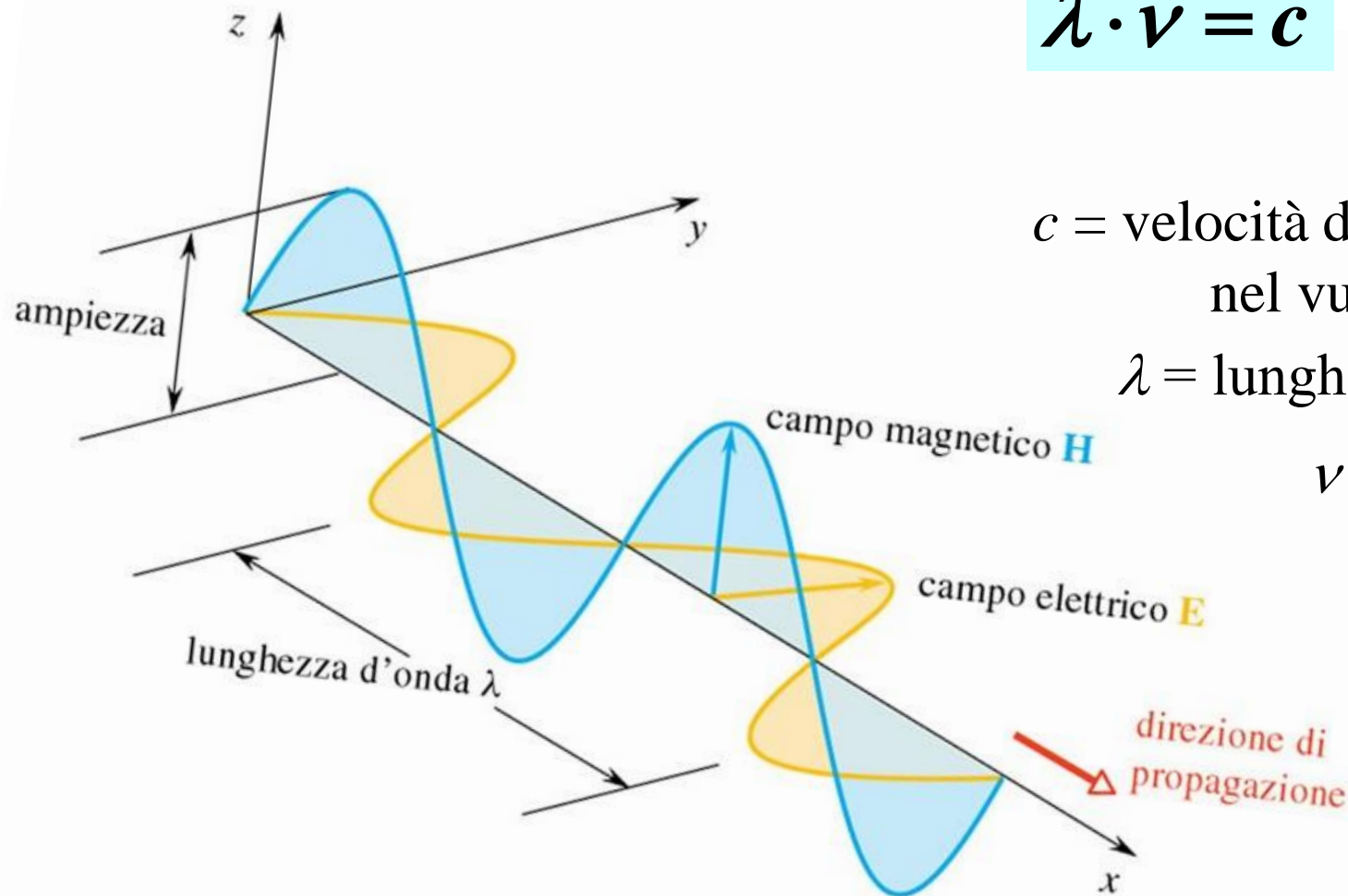

Le onde elettromagnetiche sono quantizzate

$$E = h \cdot \nu = h \frac{c}{\lambda}$$

h = costante di Planck = $6.6 \cdot 10^{-34}$ J.s

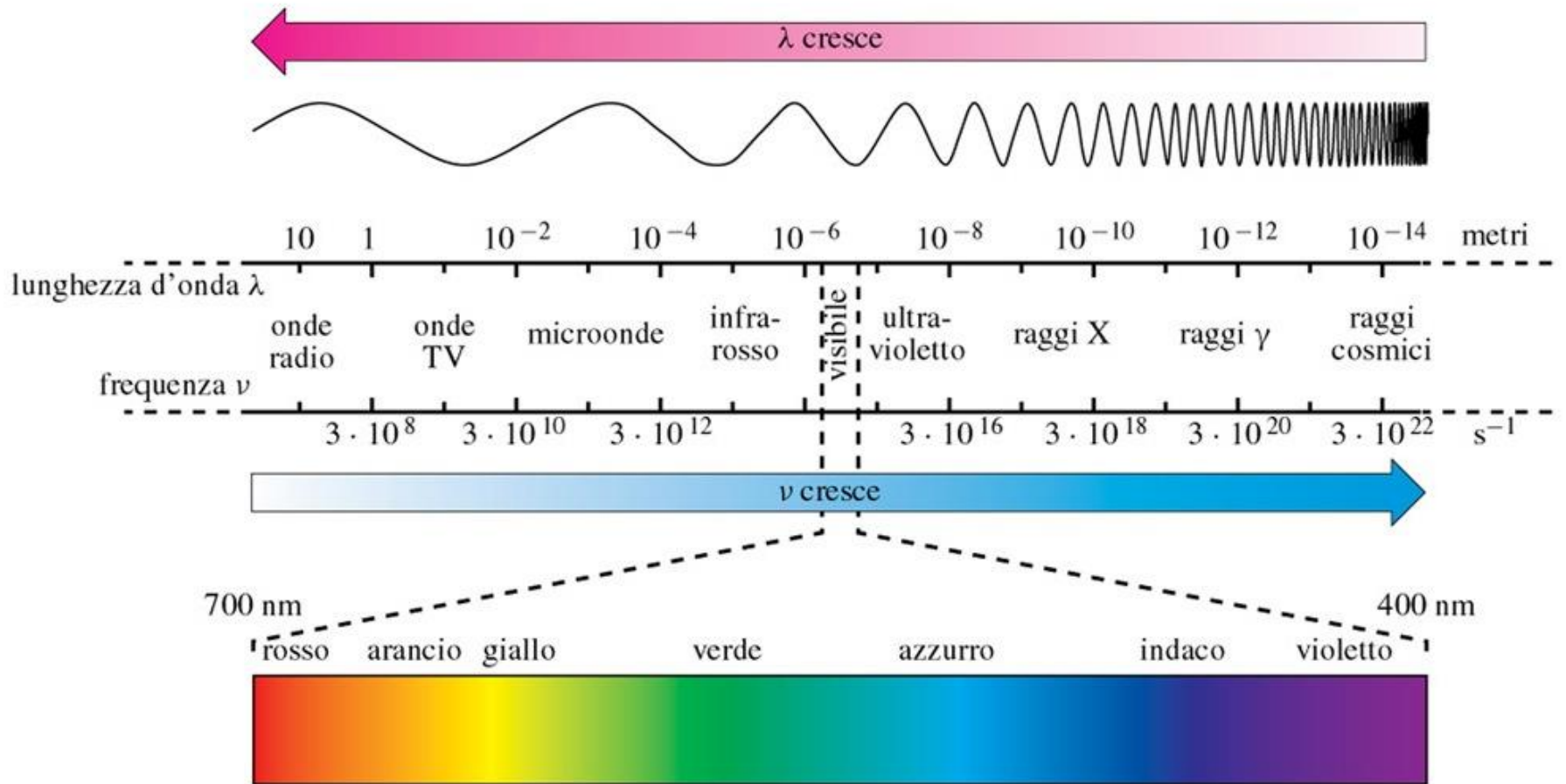

Tubo a scarica di gas
contenente idrogeno

Prisma

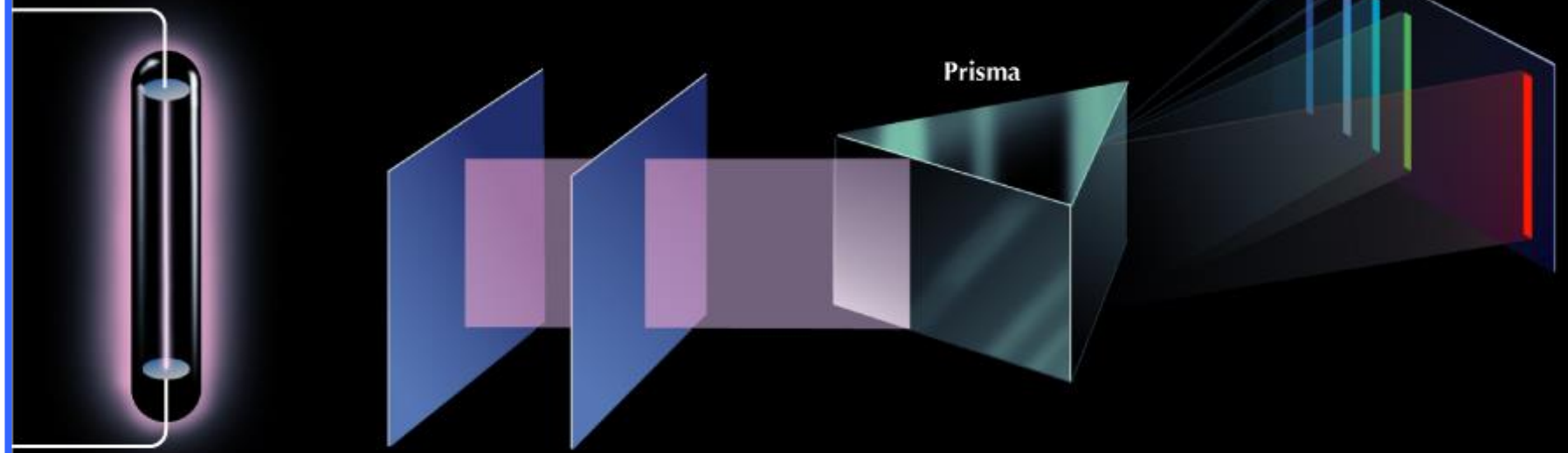

Luce bianca

Prisma

Lunghezza
d'onda crescente

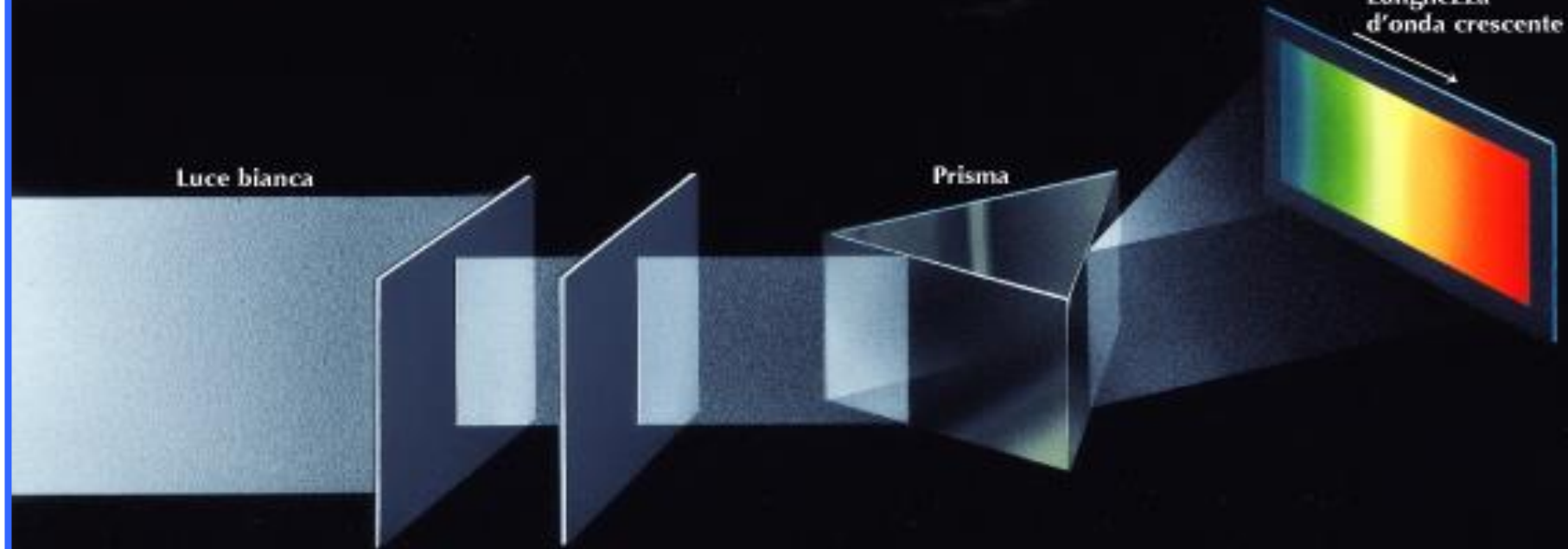

Spettro dell'atomo di Idrogeno

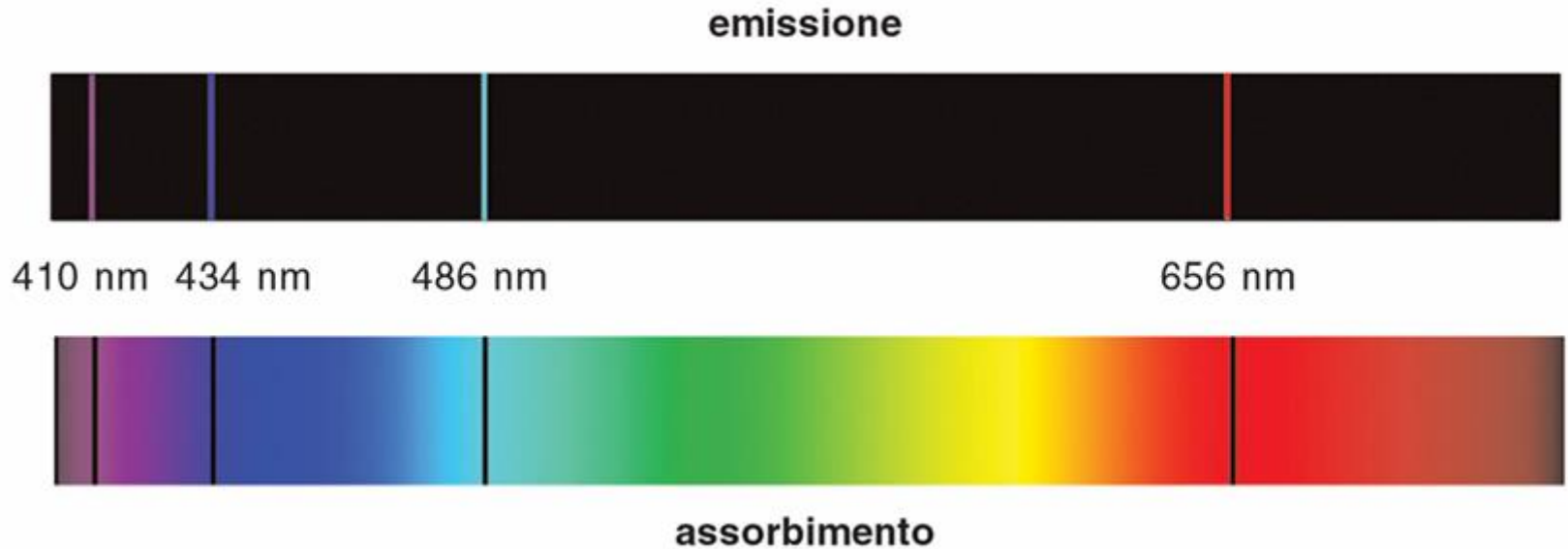

Johannes Rydberg

$$\nu = \frac{1}{\lambda} = R_H \cdot \left(\frac{1}{n_1^2} - \frac{1}{n_2^2} \right)$$

R_H = Costante di Ryberg = $1.0967 \cdot 10^7 \text{ m}^{-1}$

n_1 ed n_2 = numeri interi

Il modello atomico di Rutherford non è in grado di descrivere questo comportamento.

Modello atomo di Bohr (1913)

- L'elettrone si muove attorno al nucleo solo su determinate orbite circolari a ciascuna delle quali corrisponde un valore costante dell'energia (*stato stazionario*);
- Finché l'elettrone rimane in uno stato stazionario non assorbe e non cede energia;
- Il momento angolare (o della quantità di moto) dell'elettrone, $m \cdot v \cdot r$, è quantizzato.

$$m \cdot v \cdot r = n \cdot h / (2\pi) \quad n = 1, 2, 3, \dots, \infty$$

n viene chiamato *numero quantico principale*

ne consegue che r è quantizzato:

$$r = a_0 \cdot n^2 \quad (a_0 = 0.529 \cdot 10^{-10} \text{ m})$$

e l'energia totale risulta:

$$E = -E_0 \cdot \frac{Z^2}{n^2}$$

Johannes Rydberg

$$\Delta E = h \cdot \nu = E_0 \left(\frac{1}{n_1^2} - \frac{1}{n_2^2} \right)$$

$$\nu = \frac{1}{\lambda} = R_H \cdot \left(\frac{1}{n_1^2} - \frac{1}{n_2^2} \right)$$

Z è la carica del nucleo dell'atomo idrogenoide.



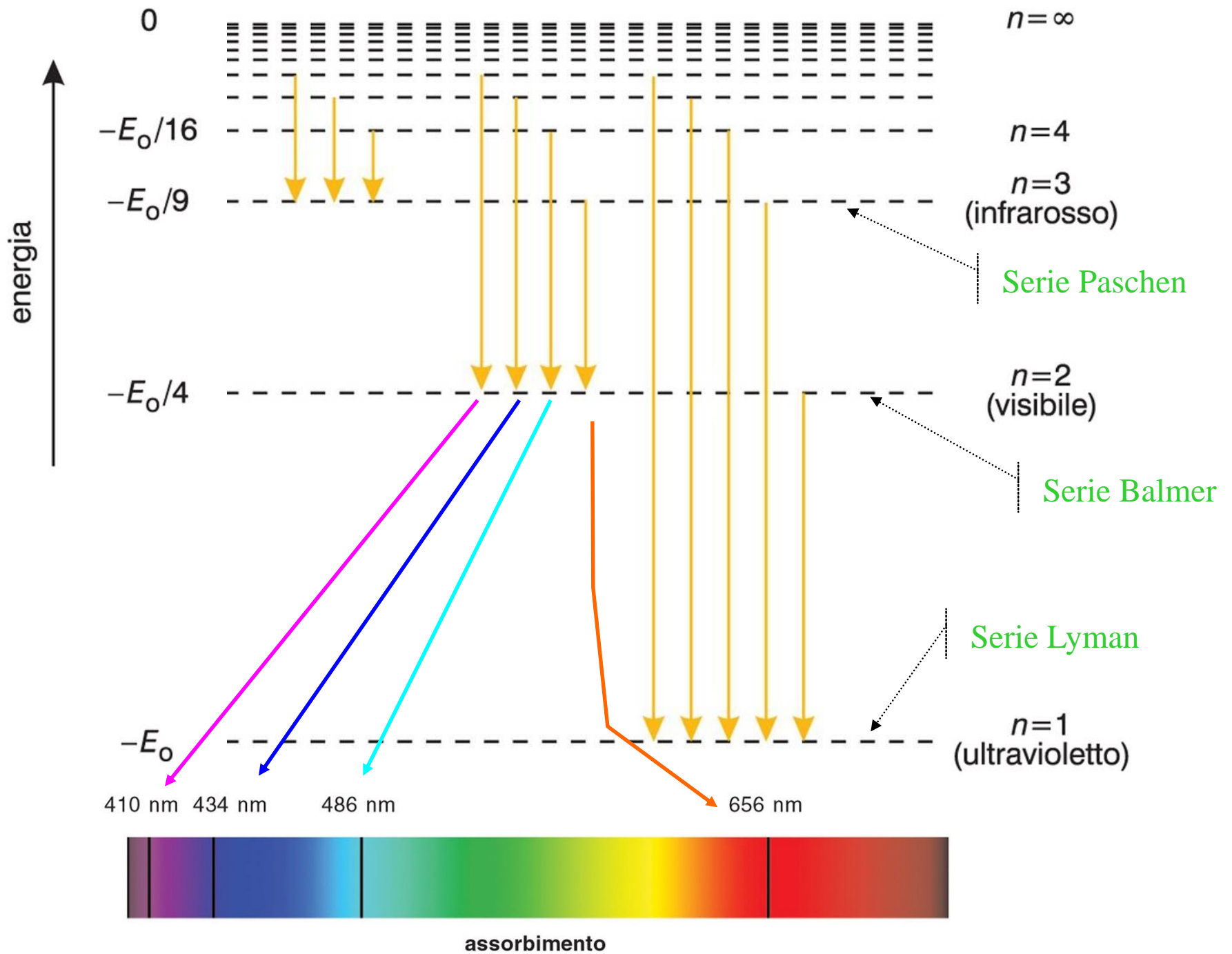

Meccanica quantistica o ondulatoria

Le onde elettromagnetiche hanno un comportamento *duale* (onda-particella)

De Broglie (1924) ipotizza un comportamento *duale* (onda-particella) anche per la **materia**

Tabella 3.1 Le lunghezze d'onda di alcuni corpi

Corpo	Massa (kg)	Velocità (m/s)	λ (m)
Elettrone veloce	$9,11 \cdot 10^{-31}$	$2,18 \cdot 10^6$	$3,34 \cdot 10^{-10}$
Palla da tennis	0,200	50,0	$6,63 \cdot 10^{-35}$
Automobile	1000,0	28,0	$2,37 \cdot 10^{-38}$

$$\lambda = \frac{h}{m \cdot v}$$

Principio di indeterminazione di Heisenberg (1927)

$$\Delta x \cdot \Delta(m \cdot v) \geq \frac{h}{4 \cdot \pi}$$

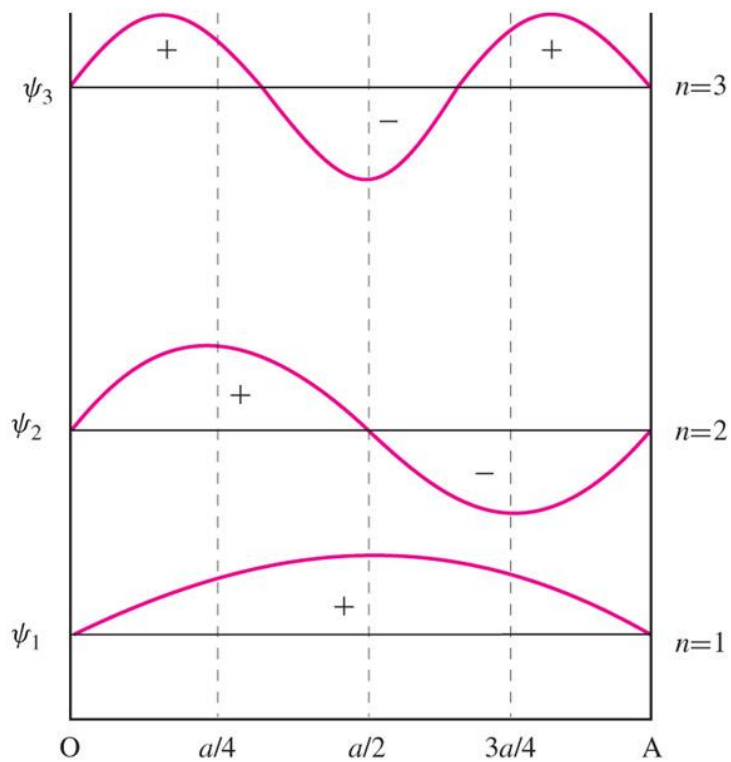

Funzione d'onda

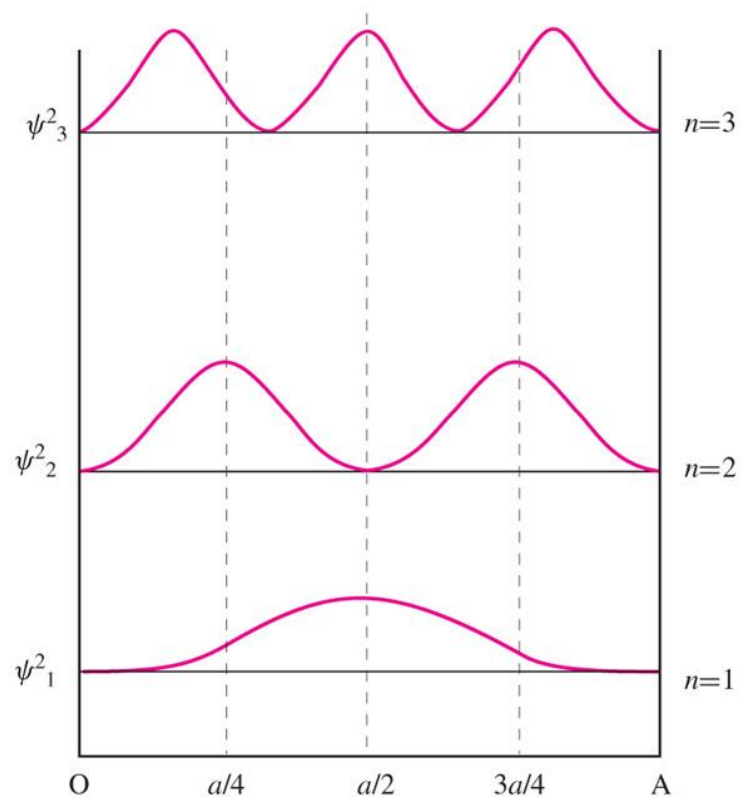

Probabilità

necessita di introdurre una nuova equazione per descrivere il comportamento ondulatorio della materia

Equazione di Schrödinger

Le cui soluzioni rappresentano *funzioni d'onda* (Ψ)

$\Psi^2(x,y,z)$, il quadrato della *funzioni d'onda* rappresenta la *densità (di probabilità)* di trovare l'elettrone in un dato punto (x,y,z) .

La soluzione dell'equazione di **Schrödinger** per l'atomo di Idrogeno evidenzia l'esistenza di stati stazionari (o orbitali elettronici) caratterizzati da 3 numeri quantici

n = numero quantico principale

l = numero quantico angolare (o secondario)

m = numero quantico magnetico

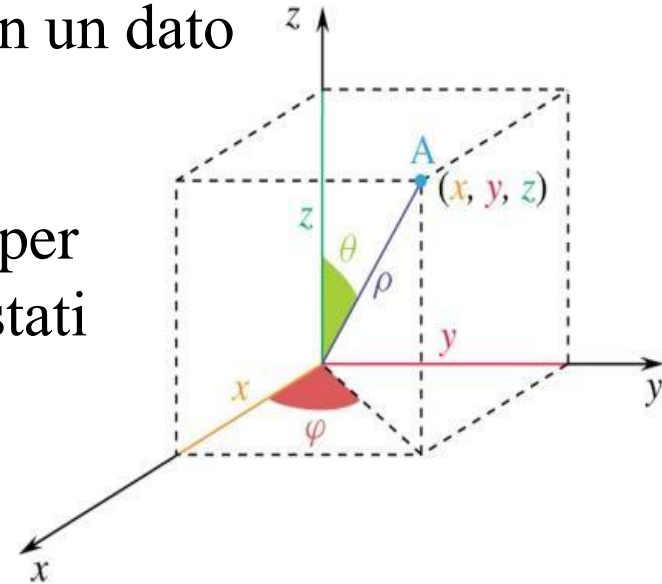

$$E = -E_0 \cdot \frac{Z^2}{n^2}$$

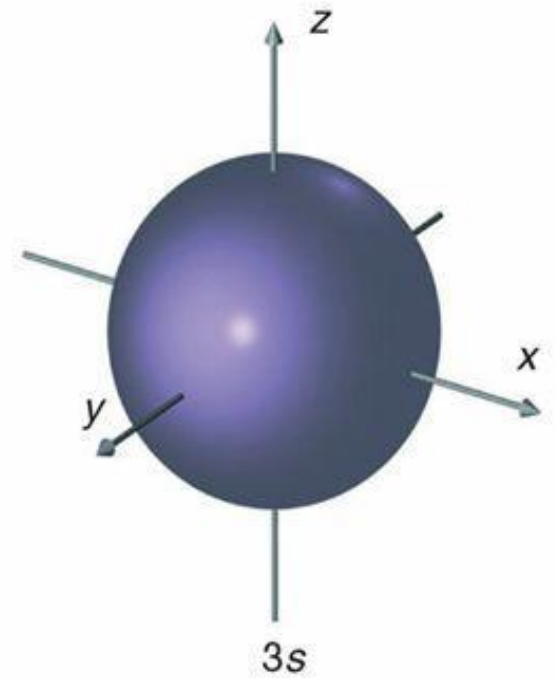
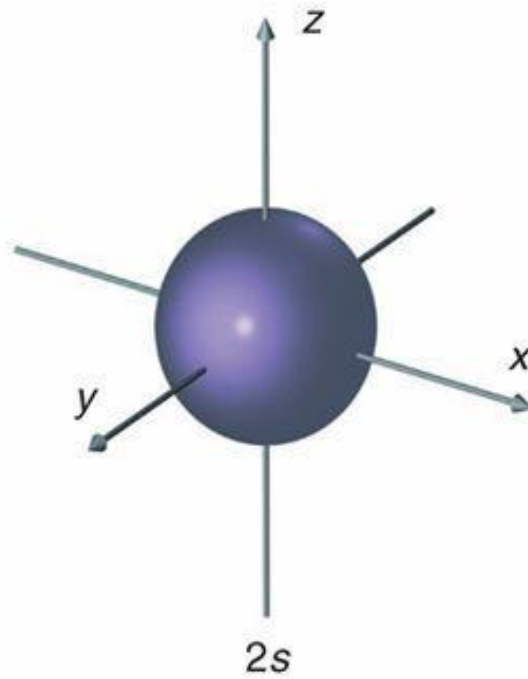
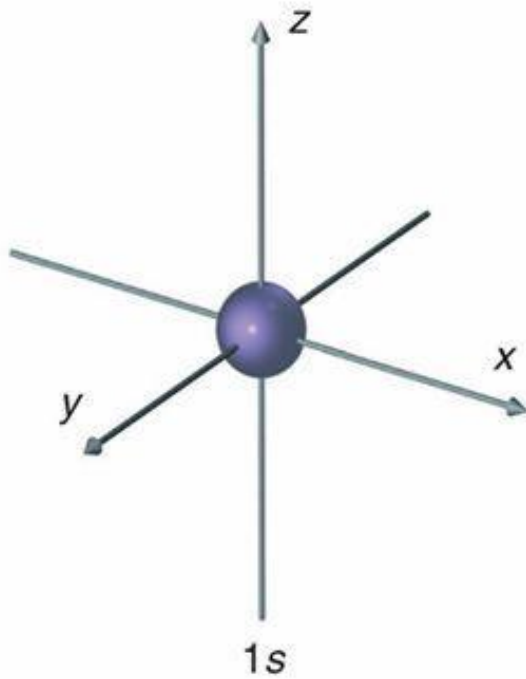
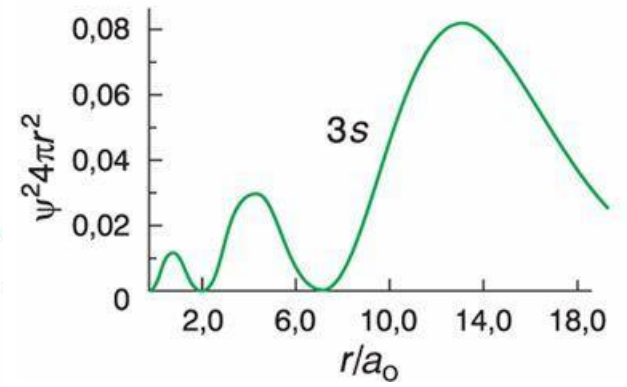
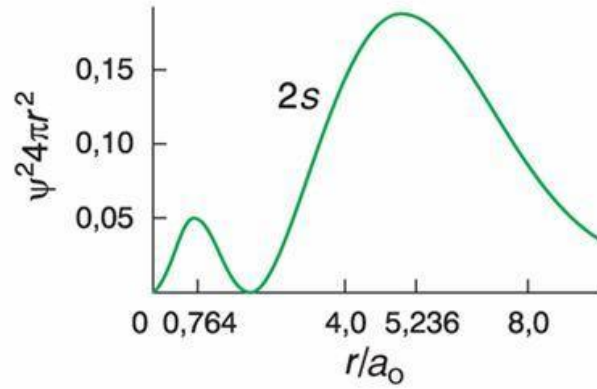
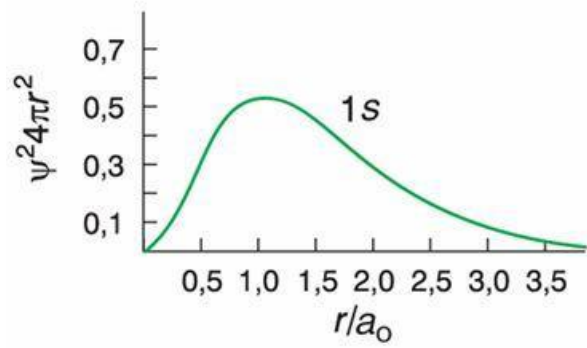

$$n = 1, 2, 3, \dots, \infty$$

$$l = 0, 1, 2, \dots, (n-1)$$

$$m = -l, -(l-1), -(l-2), \dots, 0, \dots, +(l-2), +(l-1), +l$$

$$m_s = -\frac{1}{2}, +\frac{1}{2}$$

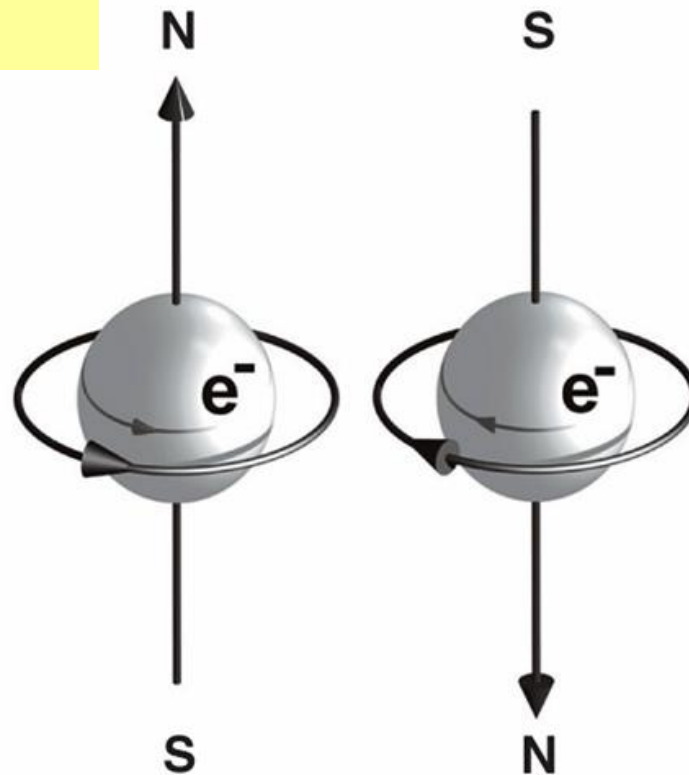

Allo spin elettronico «quantizzato»
sono associati numeri quantici di spin

$$m_s = +\frac{1}{2} \text{ e } m_s = -\frac{1}{2}$$

ogni orbitale viene indicato con un numero corrispondente ad n ed un simbolo (s, p, d, f) in base al numero quantico angolare (l)

l	0	1	2	3
Simbolo	s	p	d	f

n	l	m	orbitali	simbolo orbitali	n. totale orbitali
1	0	0	$\Psi_{1,0,0}$	1s	1
2	0	0	$\Psi_{2,0,0}$	2s	4
	1	+1, 0, -1	$\Psi_{2,1,1}, \Psi_{2,1,0}, \Psi_{2,1,-1}$		
3	0	0	$\Psi_{3,0,0}$	3s	9
	1	+1, 0, -1	$\Psi_{3,1,1}, \Psi_{3,1,0}, \Psi_{3,1,-1}$	3p	
	2	+2, +1, 0, -1, -2	$\Psi_{3,2,2}, \Psi_{3,2,1}, \Psi_{3,2,0}, \Psi_{3,2,-1}, \Psi_{3,2,-2}$	3d	
4	0	0	$\Psi_{4,0,0}$	4s	16
	1	+1, 0, -1	$\Psi_{4,1,1}, \Psi_{4,1,0}, \Psi_{4,1,-1}$	4p	
	2	+2, +1, 0, -1, -2	$\Psi_{4,2,2}, \Psi_{4,2,1}, \Psi_{4,2,0}, \Psi_{4,2,-1}, \Psi_{4,2,-2}$	4d	
	3	+3, +2, +1, 0, -1, -2, -3	$\Psi_{4,3,3}, \Psi_{4,3,2}, \Psi_{4,3,1}, \Psi_{4,3,0}, \Psi_{4,3,-1}, \Psi_{4,3,-2}, \Psi_{4,3,-3}$	4f	

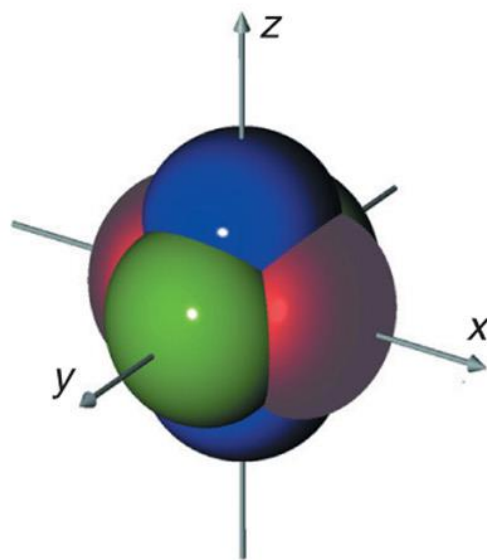
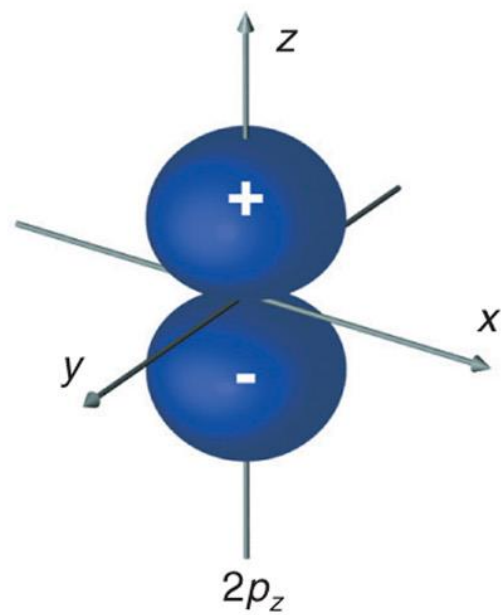
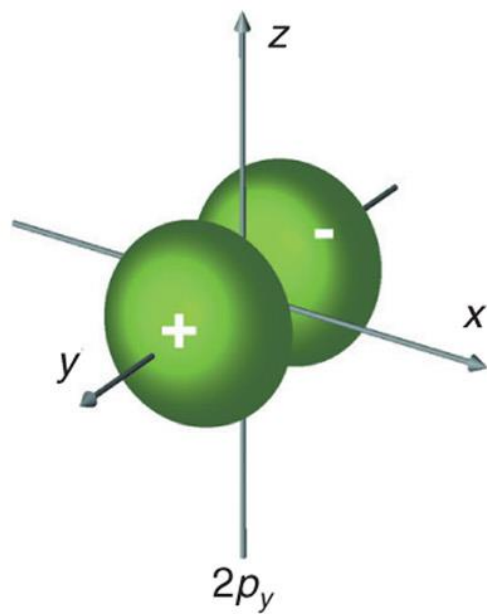
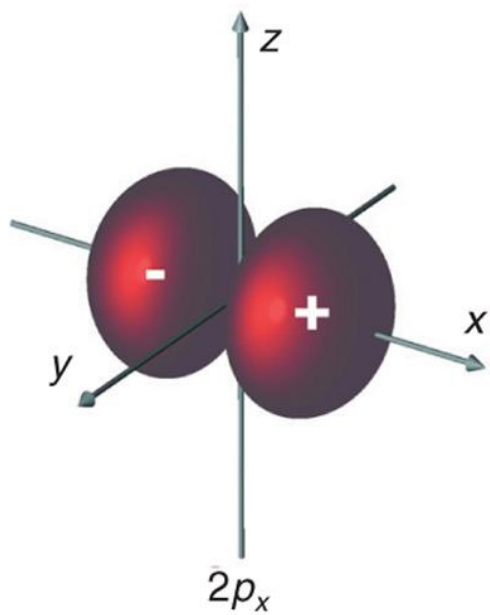

Livelli energetici

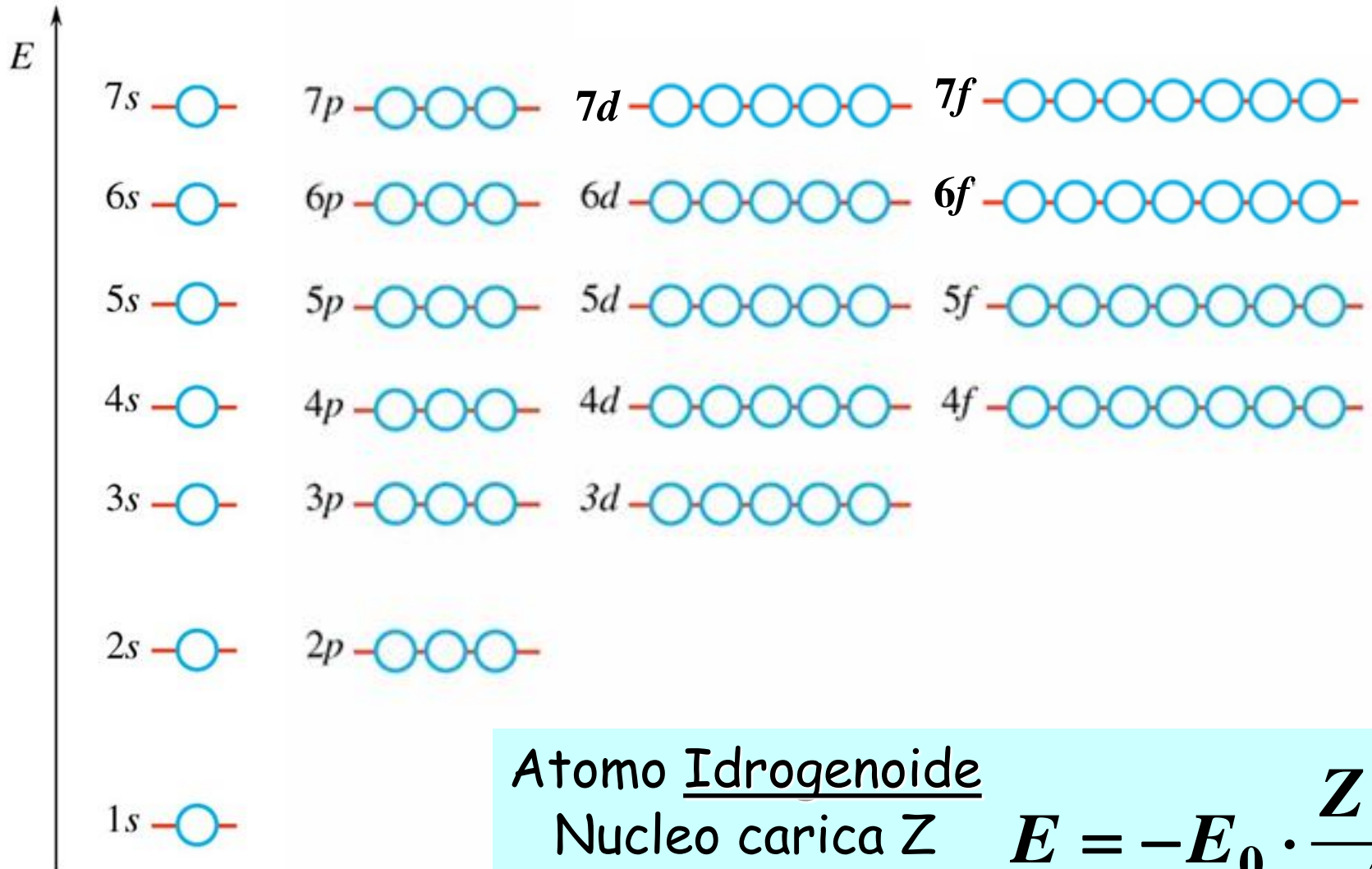

Atomo Idrogenoide

Nucleo carica Z

Un solo elettrone

$$E = -E_0 \cdot \frac{Z^2}{n^2}$$

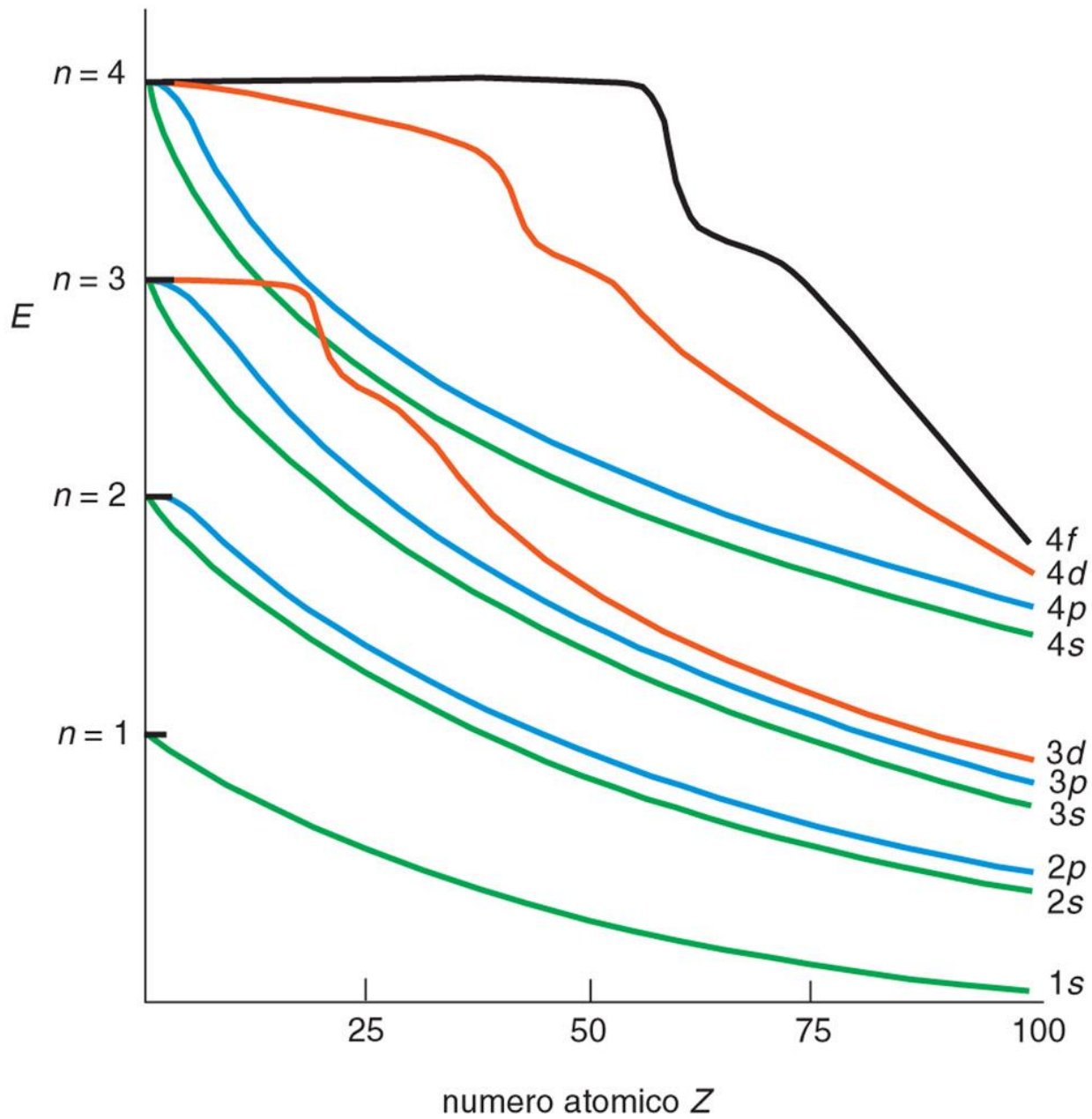

La configurazione degli atomi poli-elettronici la si determina con un «meccanismo fittizio» chiamato *Aufbau* (dal tedesco, costruzione). Consiste nell'inserire gli elettroni uno ad uno negli orbitali di più bassa energia rispettando il

Principio di esclusione di Pauli:

“in un atomo non vi possono essere due (o più) elettroni con tutti i quattro numeri quantici, n , l , m ed m_s , uguali”

e la

Regola di Hund:

“gli orbitali degeneri vengono dapprima occupati tutti singolarmente da elettroni con spin parallelo e solo successivamente da altri elettroni che si accoppiano con i precedenti”

$Z = 1 \rightarrow$ un elettrone

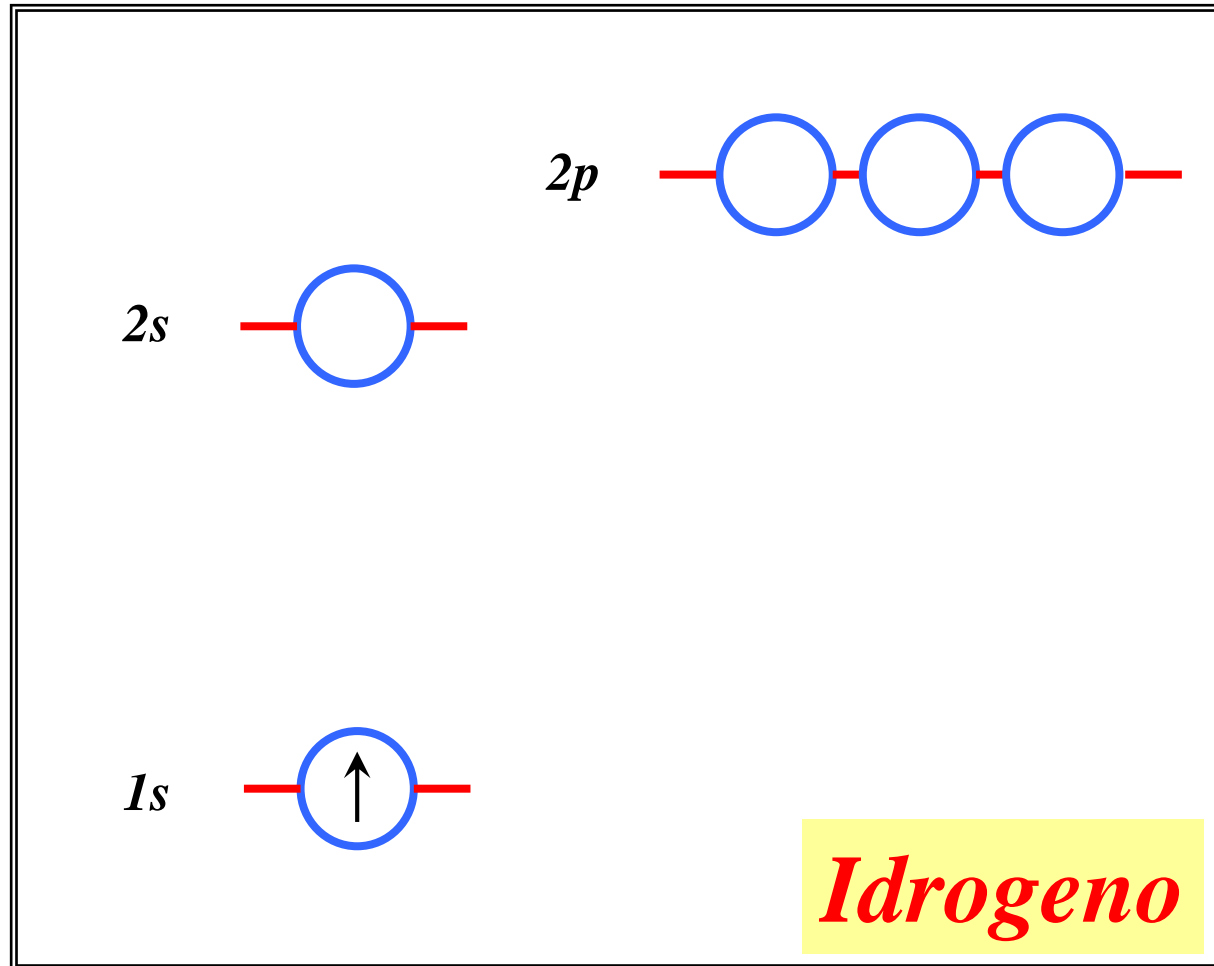

Idrogeno

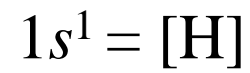

$Z = 2 \rightarrow$ due elettroni

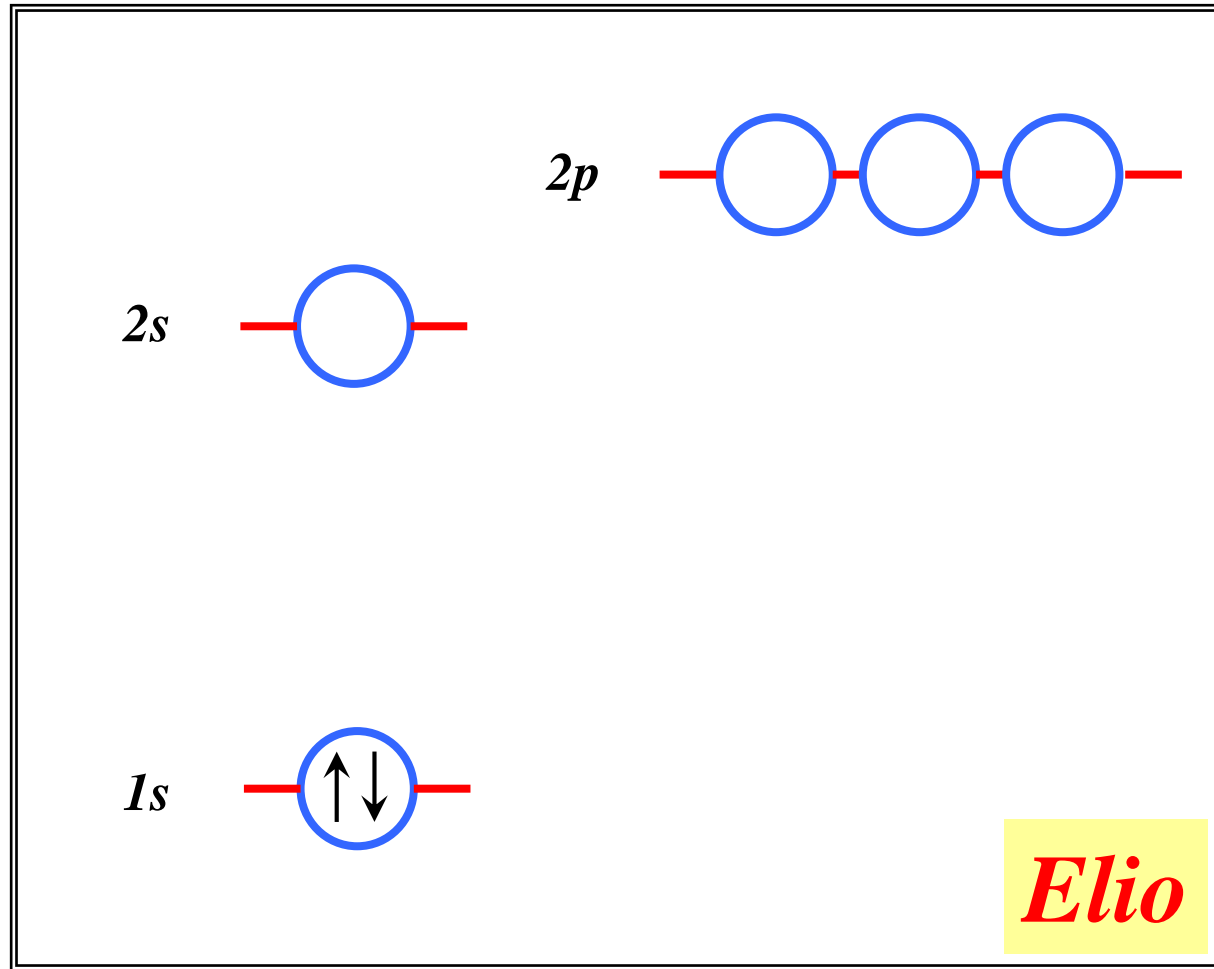

$1s^2 = [\text{He}]$

$Z = 3 \rightarrow$ tre elettroni

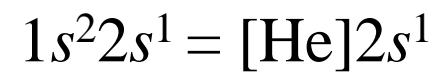
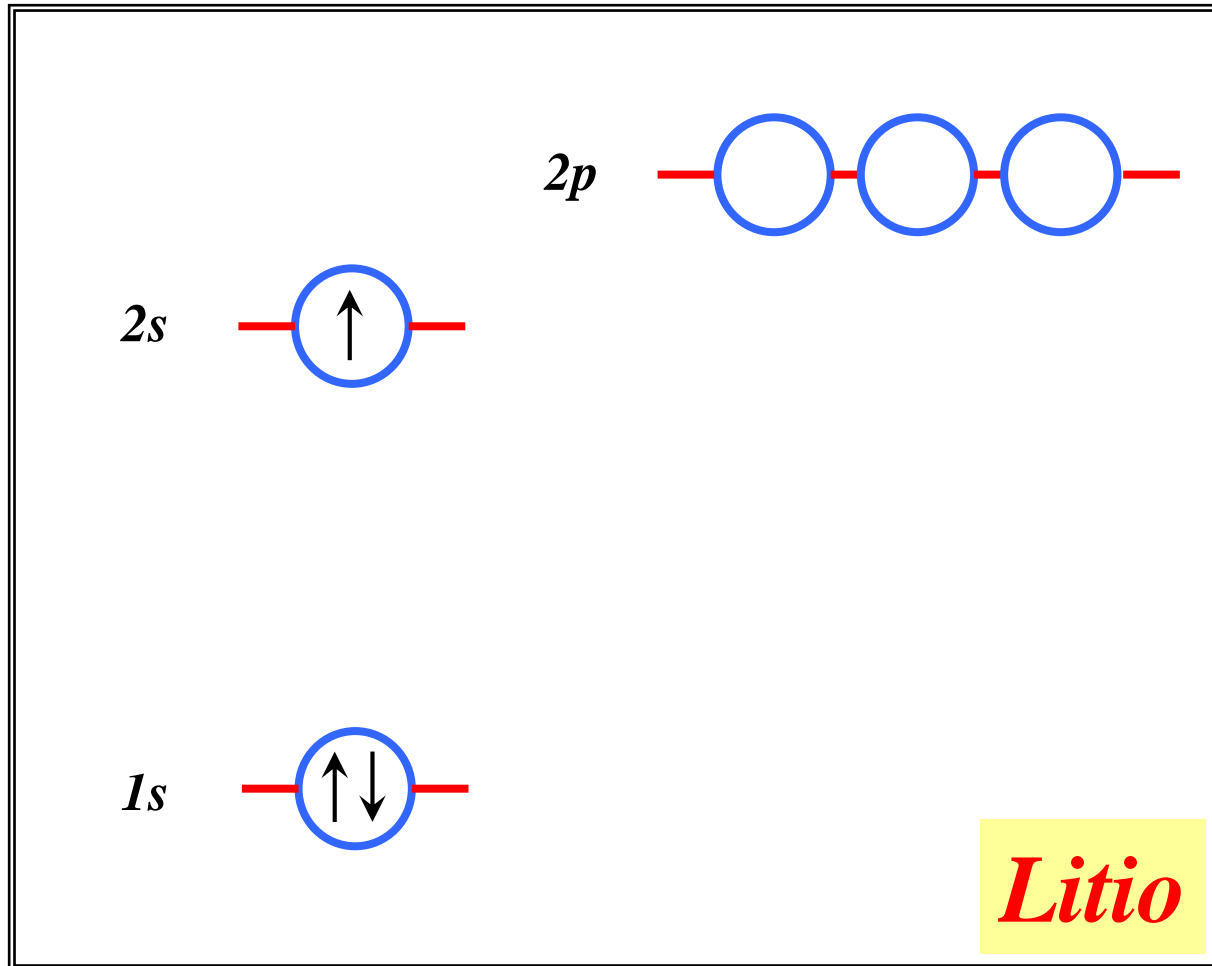

$Z = 4 \rightarrow$ quattro elettroni

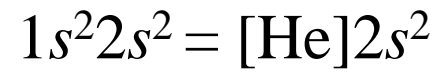
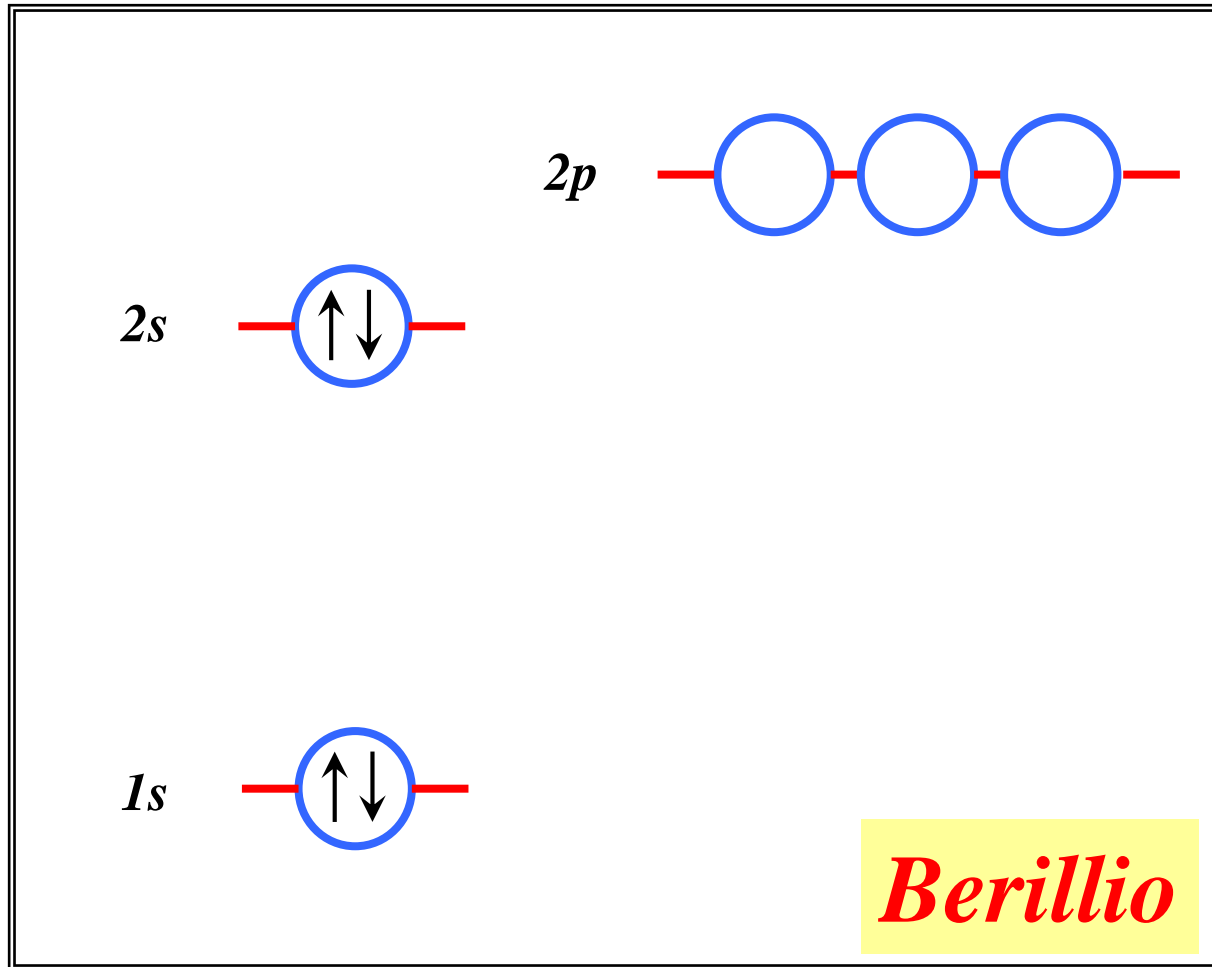

$Z = 5 \rightarrow$ cinque elettroni

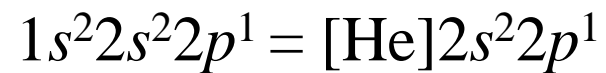
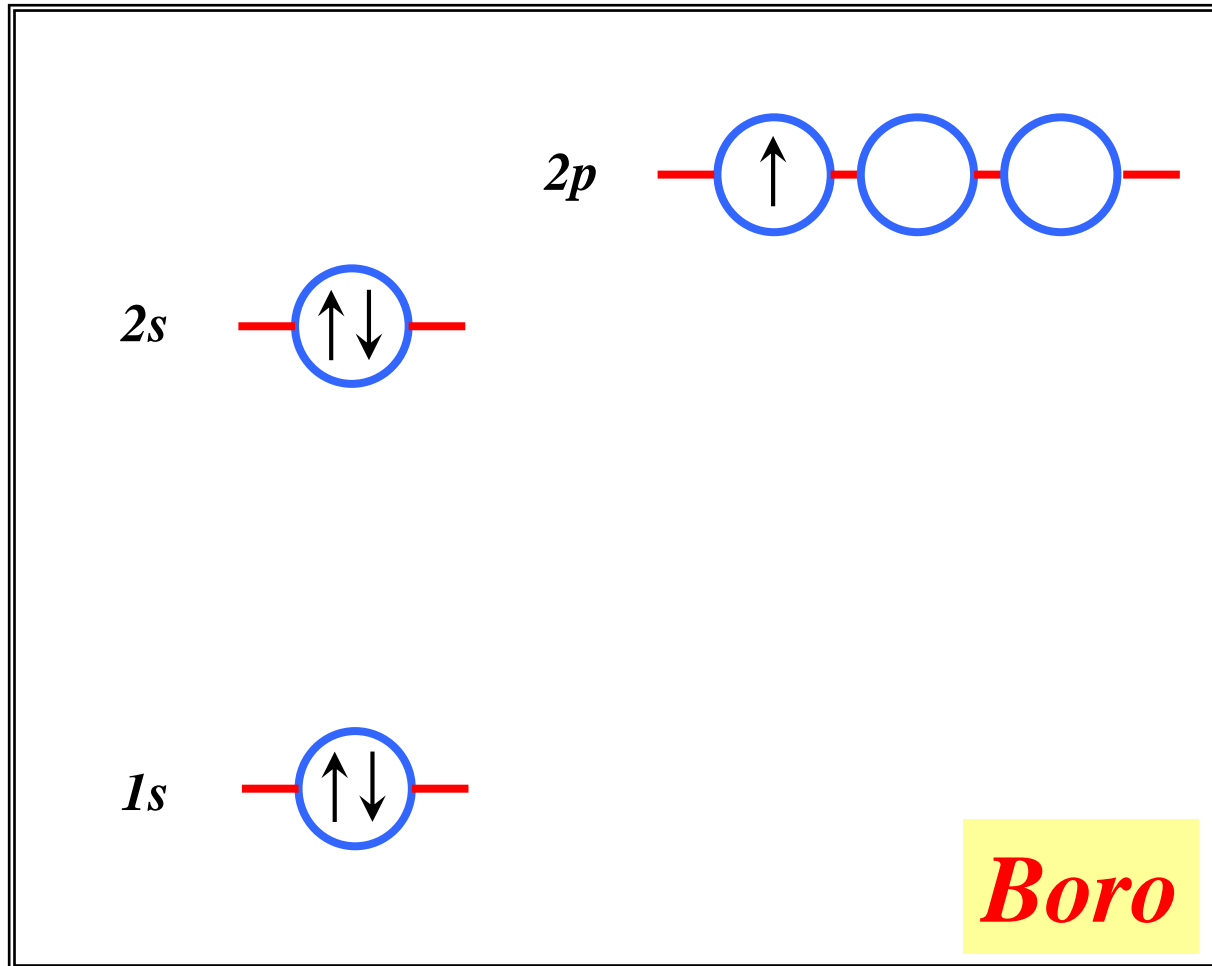

$Z = 6 \rightarrow$ sei elettroni

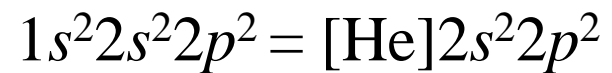
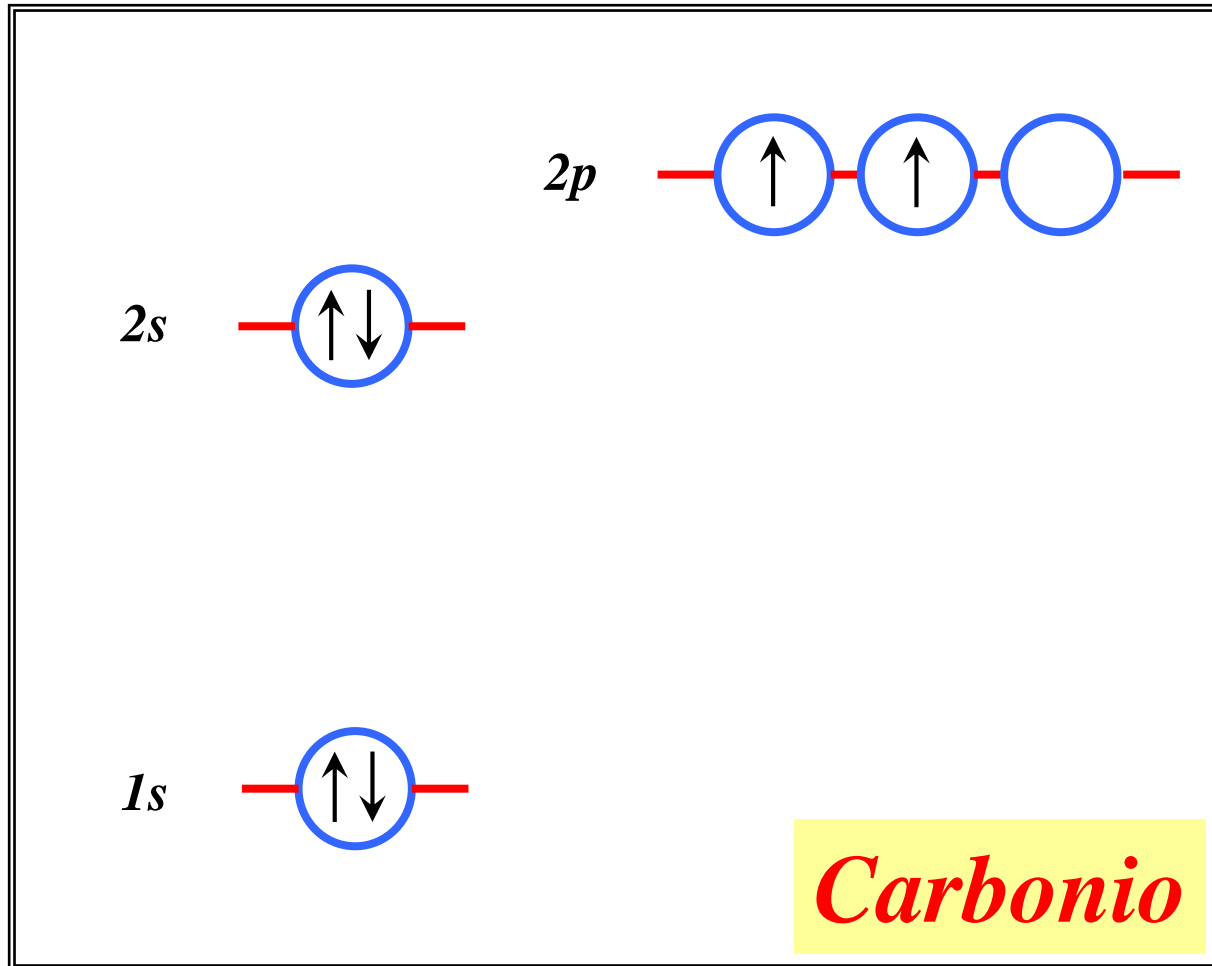

$Z = 7 \rightarrow$ sette elettroni

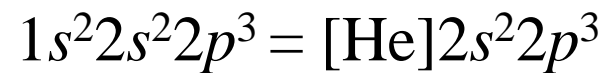
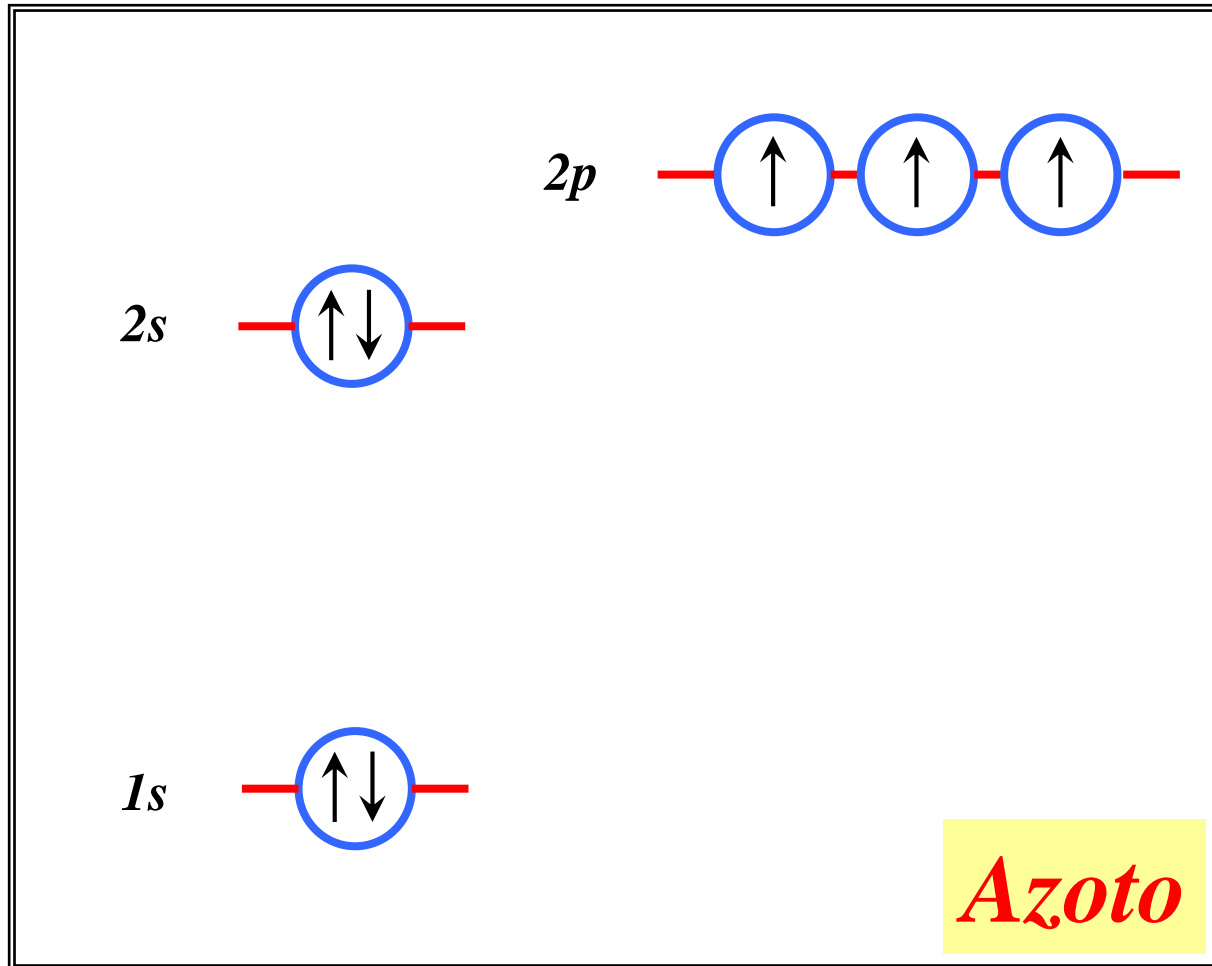

$Z = 8 \rightarrow$ otto elettroni

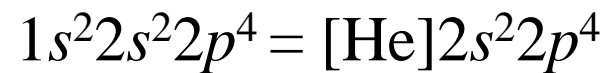
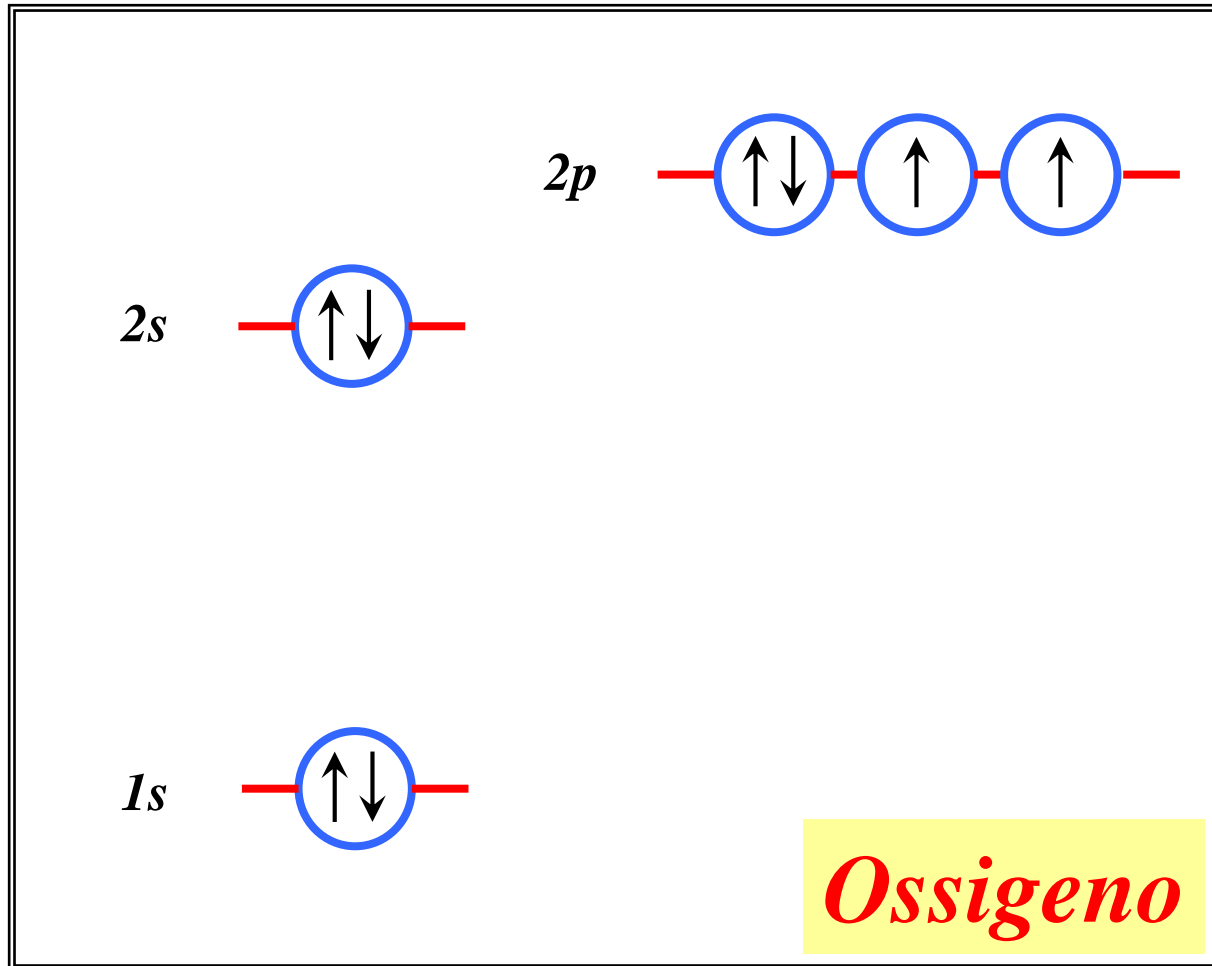

$Z = 9 \rightarrow$ nove elettroni

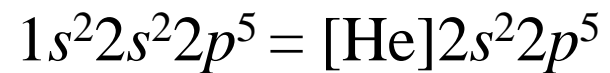
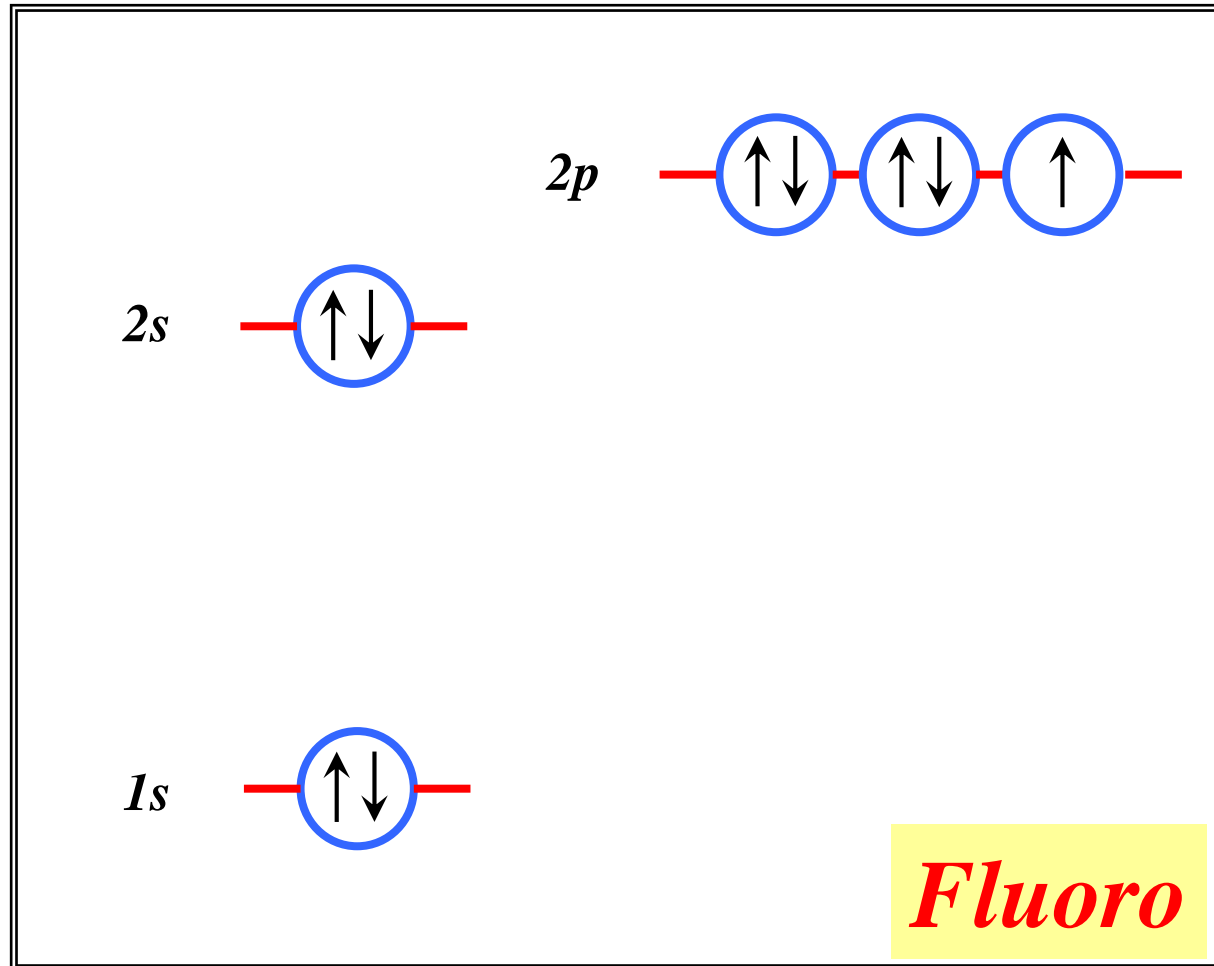

$Z = 10 \rightarrow$ dieci elettroni

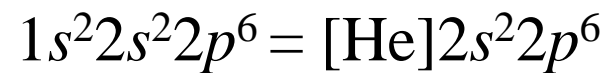
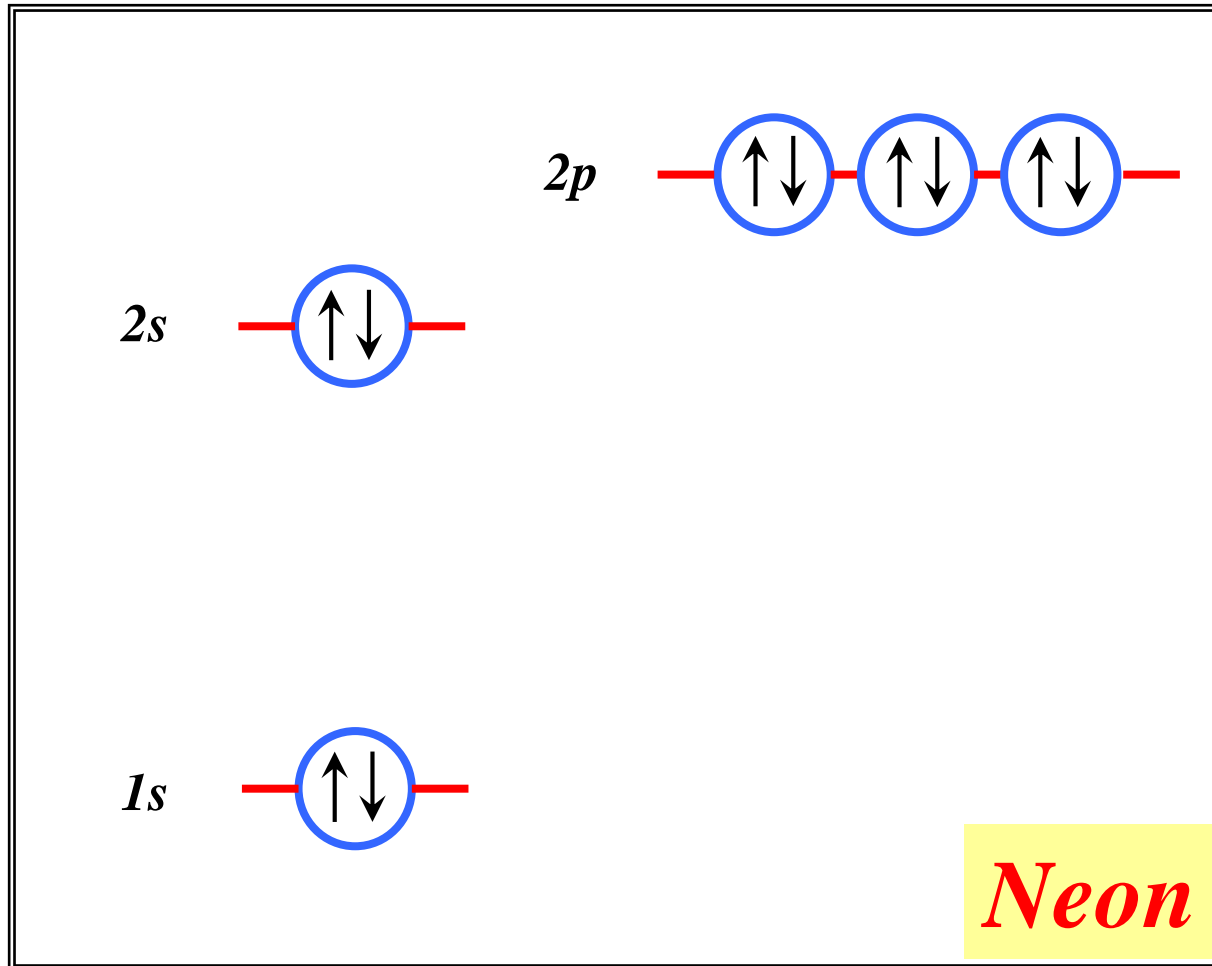

$Z = 11 \rightarrow 11$ elettroni

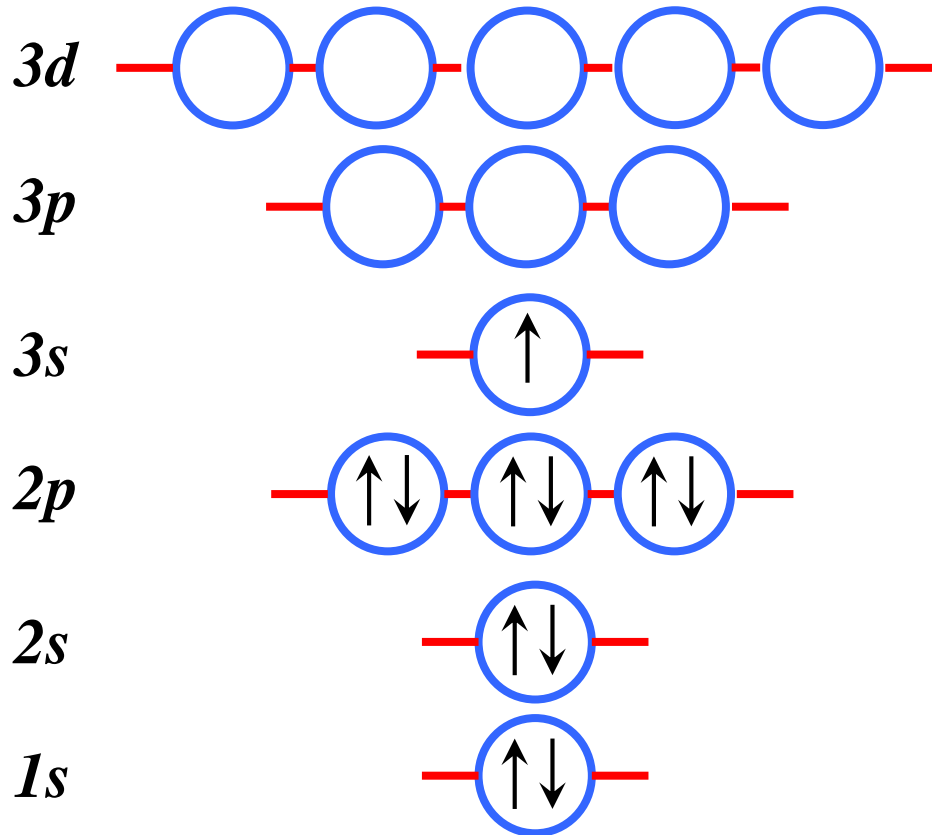

$Z = 11$ Na

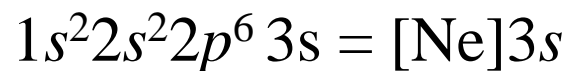

$Z = 17 \rightarrow 17$ elettroni

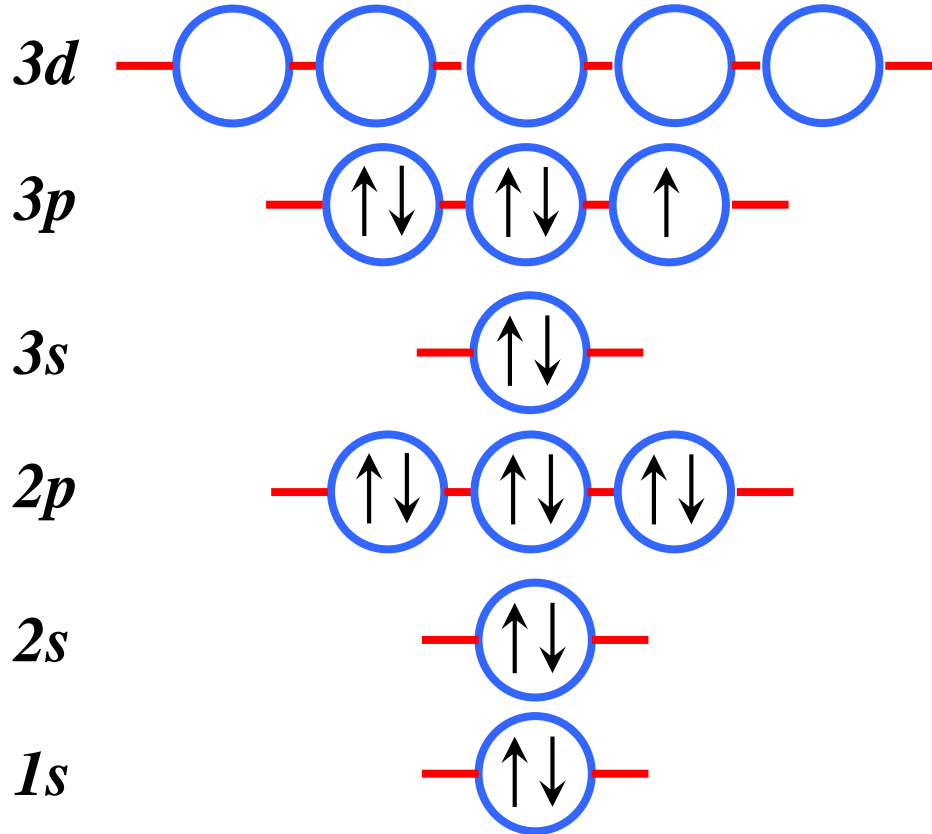

$Z = 17$

Cl

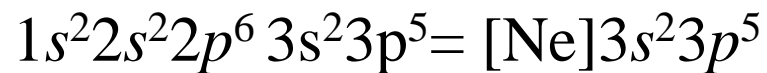

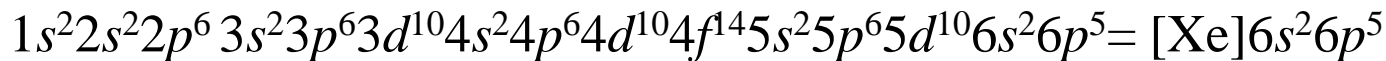
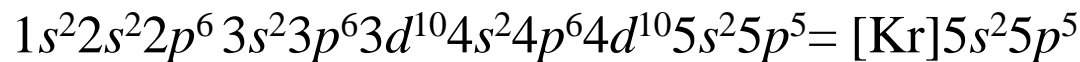
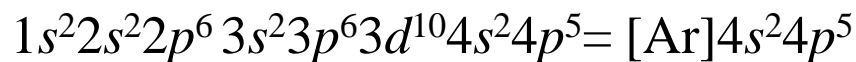
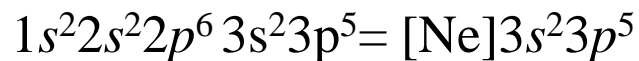
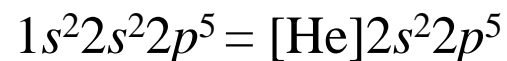



	18
	2
	He
17	4.00
9	10
F	Ne
19.00	20.18
17	18
Cl	Ar
35.45	39.95
35	36
Br	Kr
79.90	83.80
53	54
I	Xe
126.90	131.29
85	86
At	Rn
(210)	(222)

1s															1s	
2s																
3s																
4s					3d											
5s					4d											
6s					5d											
7s					6d											

							4f							
							5f							

 elementi del blocco *s*

 elementi del blocco *p*

 elementi del blocco *d*
(elementi di transizione)

 elementi del blocco *f*
lantanidi (4*f*) e attinidi (5*f*)

Tabella 3.3 Gli elementi e la loro configurazione elettronica

Numero atomico	Elemento	Configurazione elettronica	Numero atomico	Elemento	Configurazione elettronica	Numero atomico	Elemento	Configurazione elettronica
1	H	$1s^1$	36	Kr	$— 3d^{10}4s^2 4p^6$	70	Yb	$— 4f^{14}6s^2$
2	He	$1s^2$	37	Rb	$[Kr] 5s^1$	71	Lu	$— 4f^{14}5d^1 6s^2$
3	Li	$[He] 2s^1$	38	Sr	$— 5s^2$	72	Hf	$— 4f^{14}5d^2 6s^2$
4	Be	$— 2s^2$	39	Y	$— 4d^1 5s^2$	73	Ta	$— 4f^{14}5d^3 6s^2$
5	B	$— 2s^2 2p^1$	40	Zr	$— 4d^2 5s^2$	74	W	$— 4f^{14}5d^4 6s^2$
6	C	$— 2s^2 2p^2$	41	Nb	$4d^4 5s^1$	75	Re	$— 4f^{14}5d^5 6s^2$
7	N	$— 2s^2 2p^3$	42	Mo	$— 4d^5 5s^1$	76	Os	$— 4f^{14}5d^6 6s^2$
8	O	$— 2s^2 2p^4$	43	Tc	$— 4d^6 5s^1$	77	Ir	$— 4f^{14}5d^7 6s^2$
9	F	$— 2s^2 2p^5$	44	Ru	$— 4d^7 5s^1$	78	Pt	$— 4f^{14}5d^9 6s^1$
10	Ne	$— 2s^2 2p^6$	45	Rh	$4d^8 5s^1$	79	Au	$— 4f^{14}5d^{10} 6s^1$
11	Na	$[Ne] 3s^1$	46	Pd	$— 4d^{10}$	80	Hg	$— 4f^{14}5d^{10} 6s^2$
12	Mg	$— 3s^2$	47	Ag	$— 4d^{10} 5s^1$	81	Tl	$— 4f^{14}5d^{10} 6s^2 p^1$
13	Al	$— 3s^2 3p^1$	48	Cd	$— 4d^{10} 5s^2$	82	Pb	$— 4f^{14}5d^{10} 6s^2 p^2$
14	Si	$— 3s^2 3p^2$	49	In	$— 4d^{10} 5s^2 5p^1$	83	Bi	$— 4f^{14}5d^{10} 6s^2 p^3$
15	P	$— 3s^2 3p^3$	50	Sn	$— 4d^{10} 5s^2 5p^2$	84	Po	$— 4f^{14}5d^{10} 6s^2 p^4$
16	S	$— 3s^2 3p^4$	51	Sb	$— 4d^{10} 5s^2 5p^3$	85	At	$— 4f^{14}5d^{10} 6s^2 p^5$
17	Cl	$— 3s^2 3p^5$	52	Te	$— 4d^{10} 5s^2 5p^4$	86	Rn	$— 4f^{14}5d^{10} 6s^2 p^6$
18	Ar	$— 3s^2 3p^6$	53	I	$— 4d^{10} 5s^2 5p^5$	87	Fr	$[Rn] 7s^1$
19	K	$[Ar] 4s^1$	54	Xe	$— 4d^{10} 5s^2 5p^6$	88	Ra	$— 7s^2$
20	Ca	$— 4s^2$	55	Cs	$[Xe] 6s^1$	89	Ac	$— 6d^1 7s^2$
21	Sc	$— 3d^1 4s^2$	56	Ba	$— 6s^2$	90	Th	$— 6d^2 7s^2$
22	Ti	$— 3d^2 4s^2$	57	La	$— 5d^1 6s^2$	91	Pa	$— 5f^2 6d^1 7s^2$
23	V	$— 3d^3 4s^2$	58	Ce	$— 4f^2 6s^2$	92	U	$— 5f^3 6d^1 7s^2$
24	Cr	$— 3d^5 4s^1$	59	Pr	$— 4f^3 6s^2$	93	Np	$— 5f^4 6d^1 7s^2$
25	Mn	$— 3d^5 4s^2$	60	Nd	$— 4f^4 6s^2$	94	Pu	$— 5f^6 7s^2$
26	Fe	$— 3d^6 4s^2$	61	Pm	$— 4f^5 6s^2$	95	Am	$— 5f^7 7s^2$
27	Co	$— 3d^7 4s^2$	62	Sm	$— 4f^6 6s^2$	96	Cm	$— 5f^7 6d^1 7s^2$
28	Ni	$— 3d^8 4s^2$	63	Eu	$— 4f^7 6s^2$	97	Bk	$— 5f^8 6d^1 7s^2$
29	Cu	$— 3d^{10} 4s^1$	64	Gd	$— 4f^7 5d^1 6s^2$	98	Cf	$— 5f^{10} 7s^2$
30	Zn	$— 3d^{10} 4s^2$	65	Tb	$— 4f^9 6s^2$	99	Es	$— 5f^{11} 7s^2$
31	Ga	$— 3d^{10} 4s^2 4p^1$	66	Dy	$— 4f^{10} 6s^2$	100	Fm	$— 5f^{12} 7s^2$
32	Ge	$— 3d^{10} 4s^2 4p^2$	67	Ho	$— 4f^{11} 6s^2$	101	Md	$— 5f^{13} 7s^2$
33	As	$— 3d^{10} 4s^2 4p^3$	68	Er	$— 4f^{12} 6s^2$	102	No	$— 5f^{14} 7s^2$
34	Se	$— 3d^{10} 4s^2 4p^4$	69	Tm	$— 4f^{13} 6s^2$	103	Lr	$— 5f^{14} 6d^1 7s^2$
35	Br	$— 3d^{10} 4s^2 4p^5$	70	Yb	$— 4f^{14} 6s^2$			

1	2	13	14	15	16	17	18
<i>H</i>							<i>He</i>
37							(31)
<i>Li</i>	<i>Be</i>	<i>B</i>	<i>C</i>	<i>N</i>	<i>O</i>	<i>F</i>	<i>Ne</i>
152	113	83	77	75	73	71	(71)
<i>Na</i>	<i>Mg</i>	<i>Al</i>	<i>Si</i>	<i>P</i>	<i>S</i>	<i>Cl</i>	<i>Ar</i>
183	160	143	117	110	102	99	(97)
<i>K</i>	<i>Ca</i>	<i>Ga</i>	<i>Ge</i>	<i>As</i>	<i>Se</i>	<i>Br</i>	<i>Kr</i>
227	197	125	122	121	117	114	(110)
<i>Rb</i>	<i>Sr</i>	<i>In</i>	<i>Sn</i>	<i>Sb</i>	<i>Te</i>	<i>I</i>	<i>Xe</i>
247	215	163	140	141	143	133	(130)
<i>Cs</i>	<i>Ba</i>	<i>Tl</i>	<i>Pb</i>	<i>Bi</i>			
265	217	170	175	155			

Raggi atomici (metallici o covalenti), in picometri (pm), degli elementi dei gruppi principali.

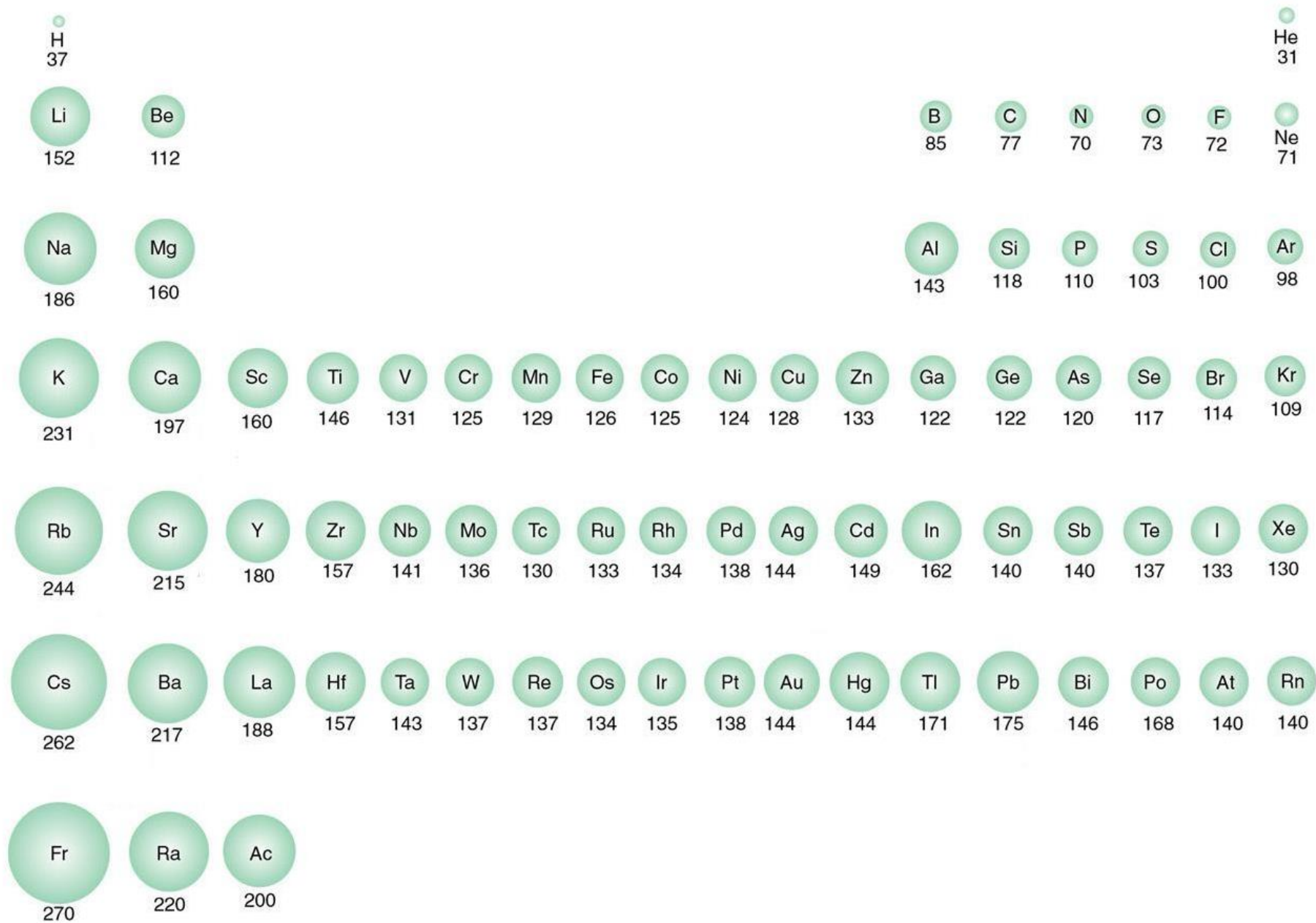

Li^+	Be^{2+}		N^{3-}	O^{2-}	F^-
76	34		171	140	133
Na^+	Mg^{2+}	Al^{3+}		S^{2-}	Cl^-
102	72	54		184	181
K^+	Ca^{2+}	Ga^{3+}		Se^{2-}	Br^-
138	100	62		198	196
Rb^+	Sr^{2+}	In^{3+}		Te^{2-}	I^-
149	126	80		207	220
Cs^+	Ba^{2+}	Tl^{3+}			
174	142	89			

Raggi ionici, in picometri (pm), di alcuni ioni.

Energia di ionizzazione

L'*energia di prima ionizzazione* (I_1), è l'energia che occorre fornire ad un atomo gassoso isolato nel suo stato fondamentale, $M(g)$, affinché perda un elettrone e si trasformi in uno ione mono positivo, $M^+(g)$, gassoso isolato:

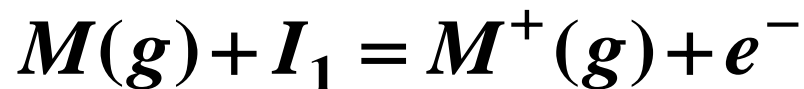

L'*energia di seconda ionizzazione* (I_2), rappresenta l'energia necessaria per allontanare un elettrone da uno ione gassoso mono positivo, $M^+(g)$, gassoso e trasformarlo in uno ione bi-positivo isolato:

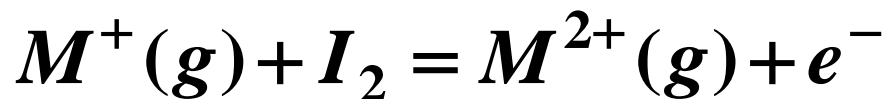

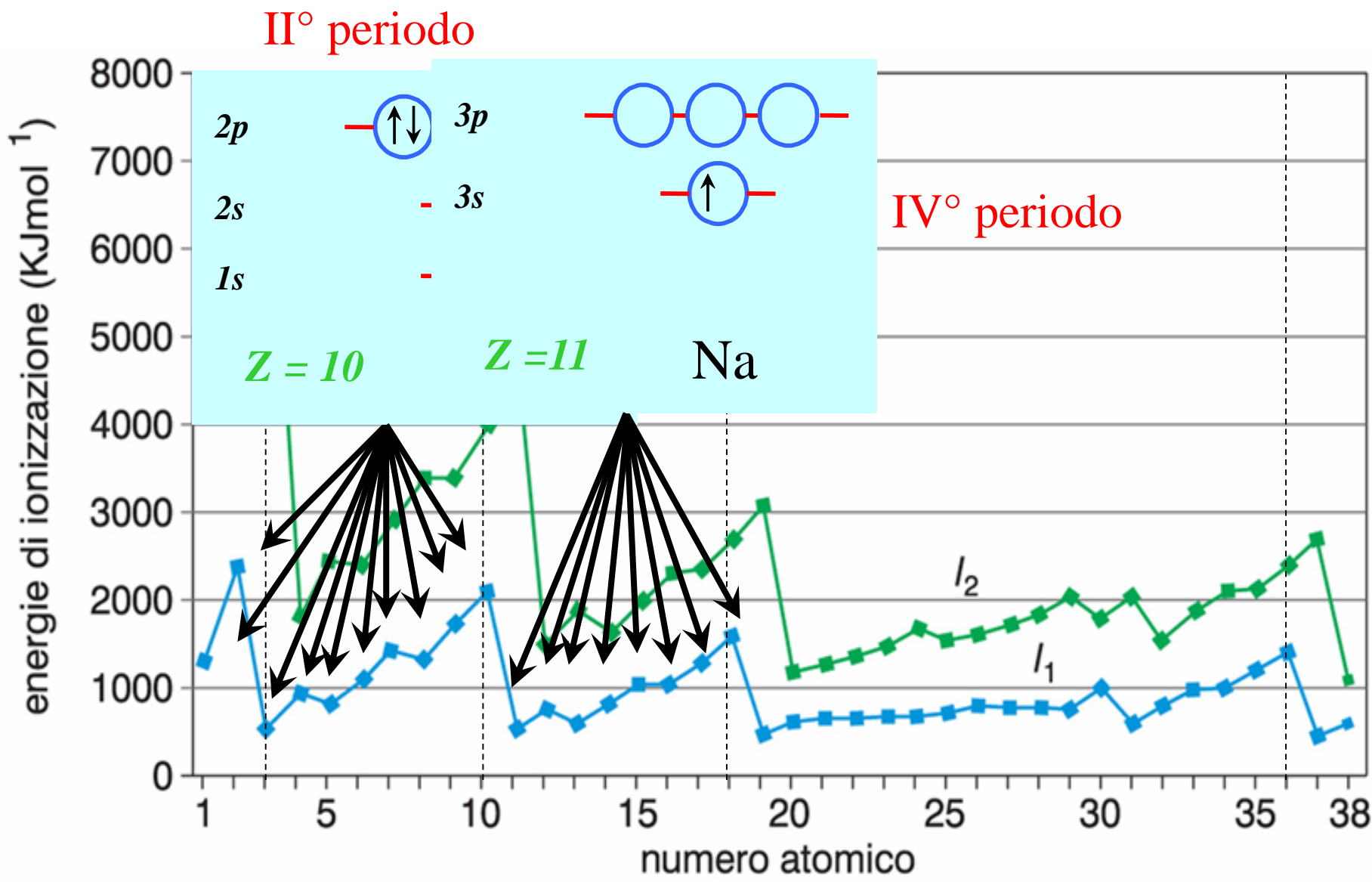

Affinità elettronica: A_e è l'energia che viene liberata da un atomo neutro isolato nel suo stato fondamentale quando acquista un elettrone per dare luogo ad uno ione negativo isolato.

Per convenzione, l'energia liberata ha segno positivo.

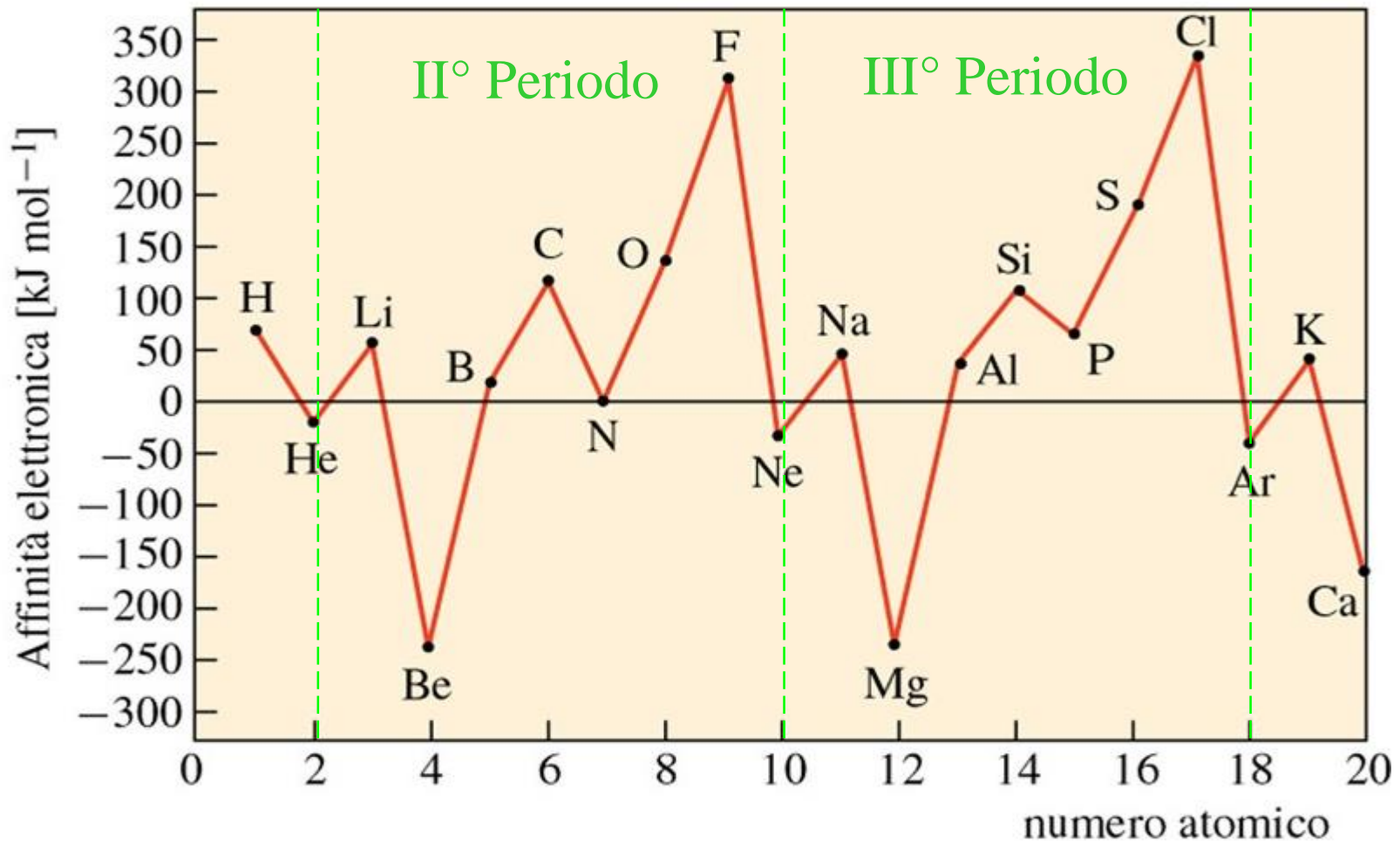
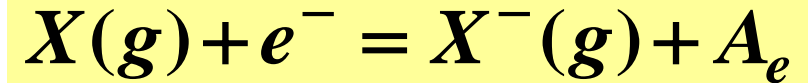

Dai *potenziali di ionizzazione* e dalle *affinità elettroniche* si evidenzia che i sistemi con *gusci elettronici chiusi* sono i più stabili.

Elementi con gusci (shell) di elettroni aperti tendono più facilmente a perdere o acquisire elettroni per ottenere una configurazione elettronica con guscio chiuso

Regola dell'ottetto (W. Kossel; 1916).

L'aggruppamento di otto elettroni s^2p^6 prende il nome di *ottetto* ed è una configurazione di grande stabilità; ... gli atomi, nella formazione dei legami, tendono a realizzare una tale configurazione elettronica esterna, cedendo, acquistando o mettendo in comune elettroni con altri atomi. (da: P. Silvestroni, 'Fondamenti di chimica', Ed. Veschi)

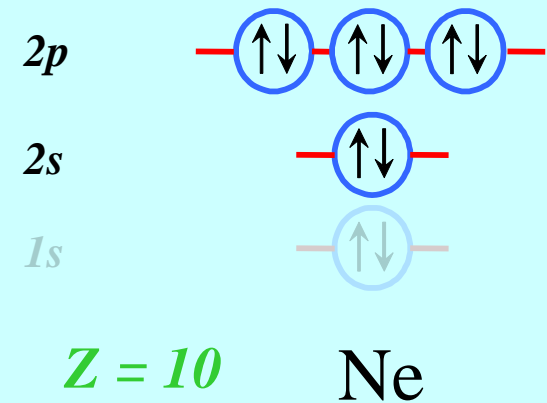

Simboli di Lewis

I II III IV V VI VII 0

H• He:

Li• Be• B• C• N• O• F• Ne•

Na• Mg• Al• Si• P• S• Cl• Ar•

