

Un campione di un liquido di massa 0.5438 g, formato da C, H e O, viene bruciato in ossigeno puro. Si ottengono 1.039 g di CO₂ ed 0.6369 g di H₂O.

Determinare la formula chimica (molecolare)

Se $X(C,H,O)$ è il nostro composto

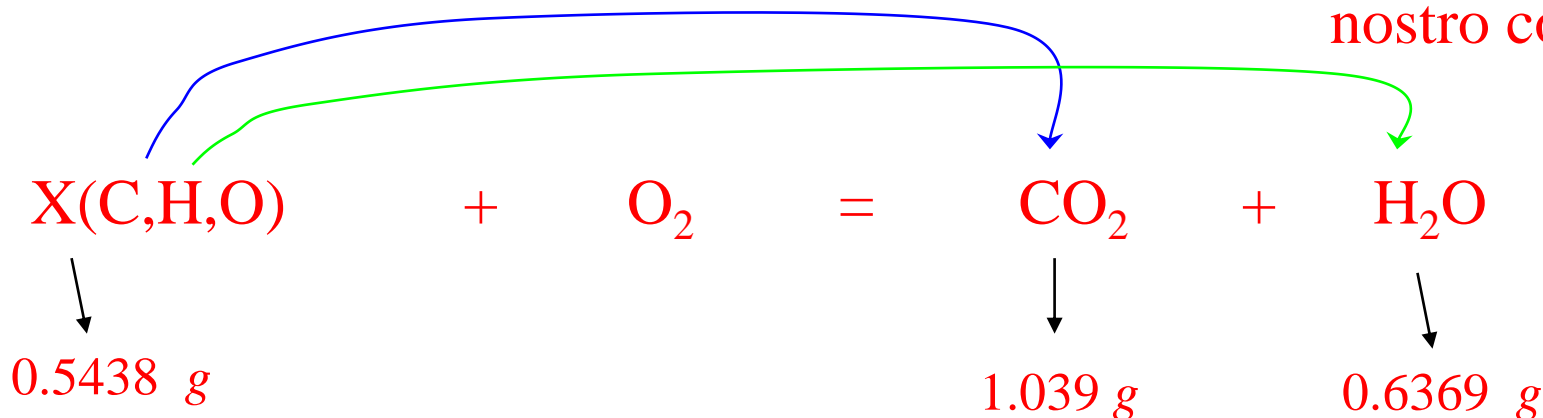

$$pm(CO_2) = 44.01 \quad pm(H_2O) = 18.02$$

$$n_{CO_2} (mol) = \frac{m_{CO_2} (g)}{M_{CO_2} (g/mol)} = \frac{1.039 \text{ g}}{44.01 \text{ g/mol}} = 0.02361 \text{ mol}$$

$$n_{H_2O} (mol) = \frac{m_{H_2O} (g)}{M_{H_2O} (g/mol)} = \frac{0.6369 \text{ g}}{18.02 \text{ g/mol}} = 0.03534 \text{ mol}$$



$$n_{\text{C}} (\text{mol}) = n_{\text{CO}_2} (\text{mol}) = 0.02361 \text{ mol}$$

$$\begin{aligned} m_{\text{C}} (\text{g}) &= n_{\text{C}} (\text{mol}) \cdot M_{\text{C}} (\text{g/mol}) = 0.02361 \text{ mol} \cdot 12.01 \text{ g/mol} \\ &= 0.2836 \text{ g} \end{aligned}$$

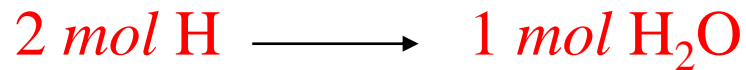

$$n_{\text{H}} (\text{mol}) = 2 \cdot n_{\text{H}_2\text{O}} (\text{mol}) = 2 \cdot 0.03534 \text{ mol} = 0.07068 \text{ mol}$$

$$\begin{aligned} m_{\text{H}} (\text{g}) &= n_{\text{H}} (\text{mol}) \cdot M_{\text{H}} (\text{g/mol}) = 0.07068 \text{ mol} \cdot 1.008 \text{ g/mol} \\ &= 0.07125 \text{ g} \end{aligned}$$

$$m_{X(C,H,O)} = m_C + m_H + m_O$$

$$m_O = m_{X(C,H,O)} - m_C - m_H$$

$$m_O = 0.5438 - 0.2836 - 0.07125 = 0.1890 \text{ g}$$

$$n_O (\text{mol}) = \frac{m_O (\text{g})}{M_O (\text{g/mol})} = \frac{0.1890 \text{ g}}{16.00 \text{ g/mol}} = 0.01181 \text{ mol}$$

$$n_C (\text{mol}) = 0.02361 \text{ mol}$$

$$n_H (\text{mol}) = 0.07068 \text{ mol}$$

$$n_O (\text{mol}) = 0.01181 \text{ mol}$$

$$\begin{array}{ccc} \text{C} & \text{H} & \text{O} \\ \frac{0.02361}{0.01181} & \frac{0.07068}{0.01181} & \frac{0.01181}{0.01181} \end{array}$$

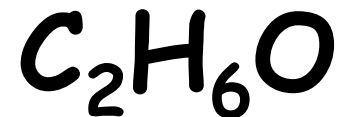

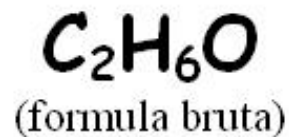

alcol etilico

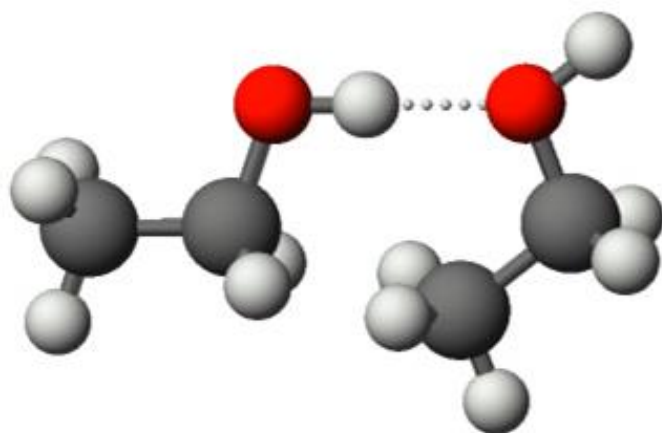

etere dimetilico

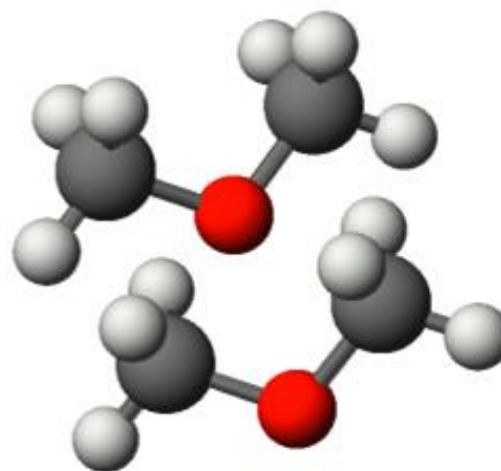

Composto	Momento di dipolo, D	Punto di fusione, °C	Punto di ebollizione, °C
alcol etilico	1.69	-114.1	78.29
etere dimetilico	1.30	-141.5	-24.8

Legame Chimico

Fra due o più atomi esiste un *legame chimico* se le forze agenti fra di essi danno luogo alla formazione di un *aggregato di atomi* sufficientemente *stabile* da consentire di svelarne l'esistenza (L. Pauling).

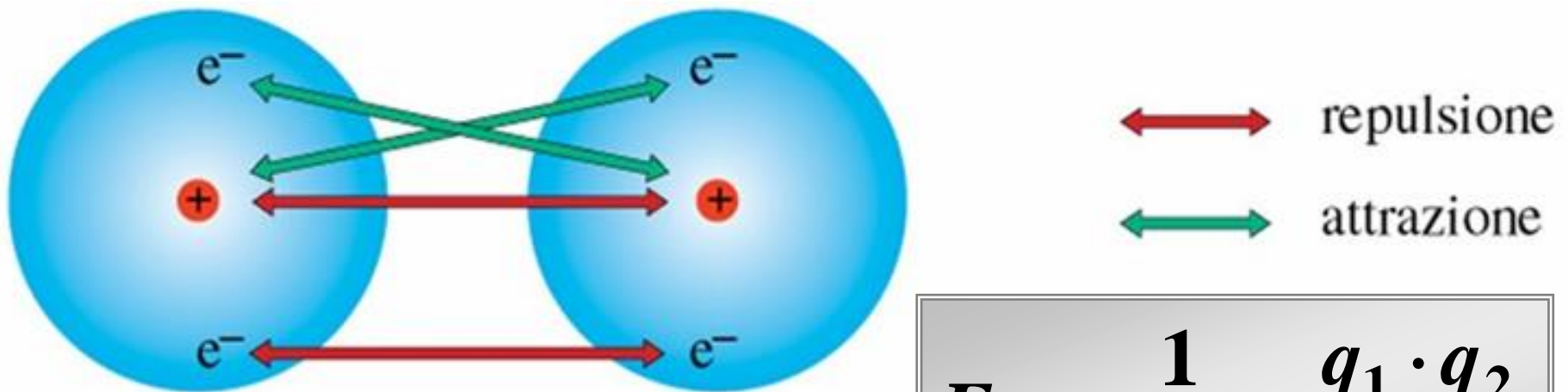

$$F = \frac{1}{4\pi\epsilon_0} \cdot \frac{q_1 \cdot q_2}{r_{12}^2}$$

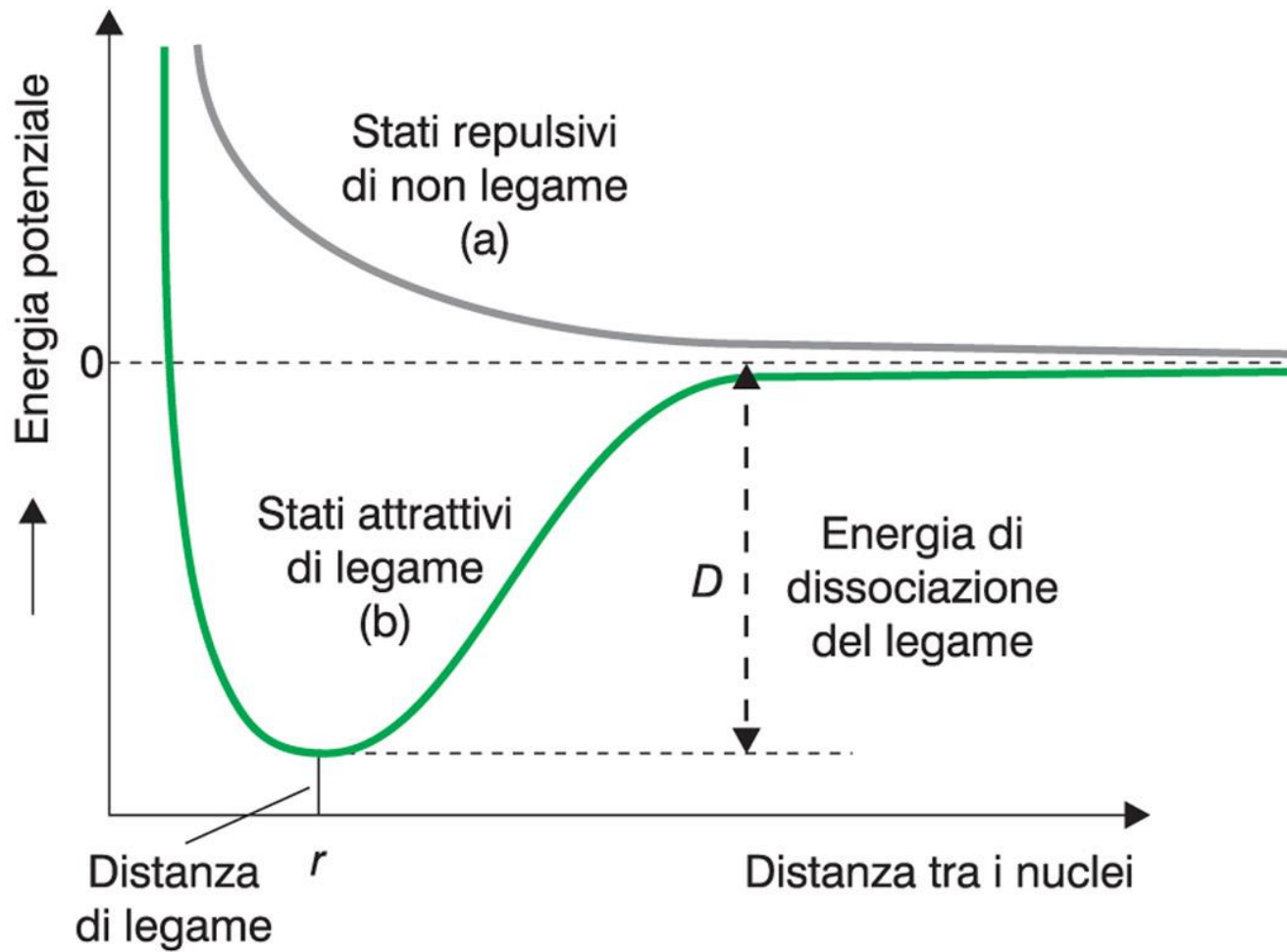

Dai *potenziali di ionizzazione* e dalle *affinità elettroniche* si evidenzia che i sistemi con *gusci elettronici chiusi* sono i più stabili.

Elementi con gusci (shell) di elettroni aperti tendono più facilmente a perdere o acquisire elettroni per ottenere una configurazione elettronica con guscio chiuso

Regola dell'ottetto (W. Kossel; 1916).

L'aggruppamento di otto elettroni s^2p^6 prende il nome di *ottetto* ed è una configurazione di grande stabilità; ... gli atomi, nella formazione dei legami, tendono a realizzare una tale configurazione elettronica esterne, cedendo o acquistando o mettendo in comune elettroni con altri atomi. (da: P. Silvestroni, 'Fondamenti di chimica', Ed. Veschi)

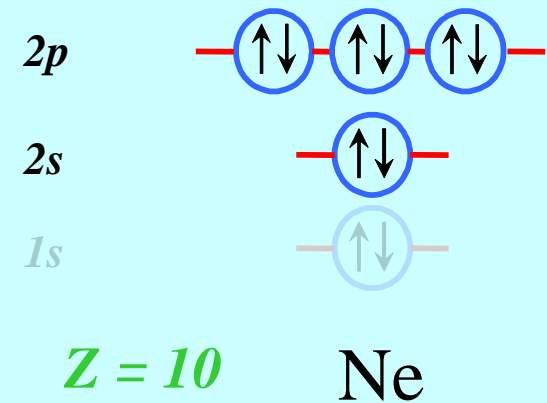

Carattere del Legame Chimico

1. Legame Metallico

2. Legame Ionico

3. Legame Covalente

- Omeopolare
- Eteropolare
- Dativo

-DEBOLI-

4. Legame Dipolare

- dipolo - dipolo
- dipolo - dipolo indotto
- dipolo indotto - dipolo indotto

5. Legame Idrogeno

Legame Metallico

I metalli hanno *basse energie di ionizzazione*
e *bassa elettronegatività*

Ogni atomo condivide con tutti gli altri atomi uno o più elettroni diventando uno ione positivo (rispettando la regola dell'ottetto). Gli elettroni si de-localizzano su tutto il cristallo metallico neutralizzando l'eccesso di carica (+).

Proprietà dei metalli

- *elevata conducibilità elettrica e termica*
- *duttilità e malleabilità*
- *struttura compatta*
- *opacità*

Legame Ionico

Legame di natura *elettrostatica* che si forma tra un *elemento* con bassa energia di ionizzazione (**metallo**) ed un *elemento* con un alta affinità elettronica (non-metallo)

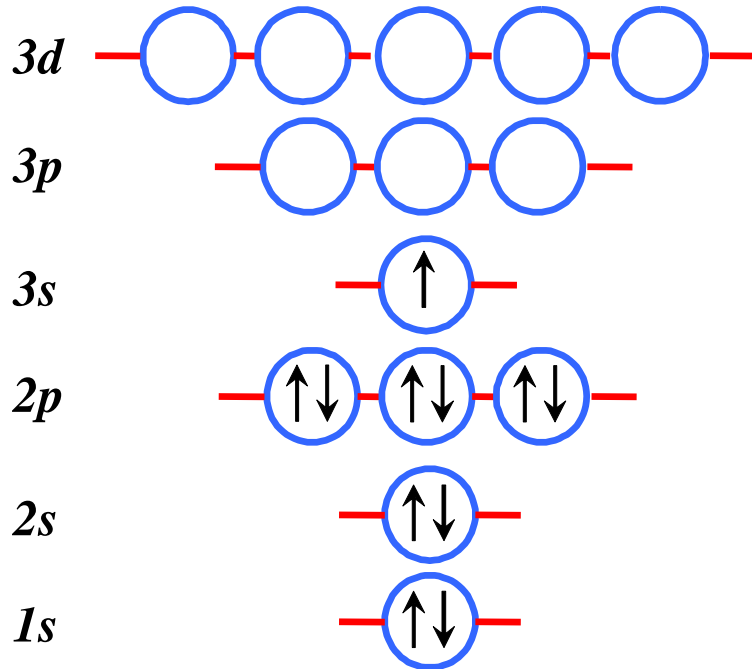

$Z = 11$ Na

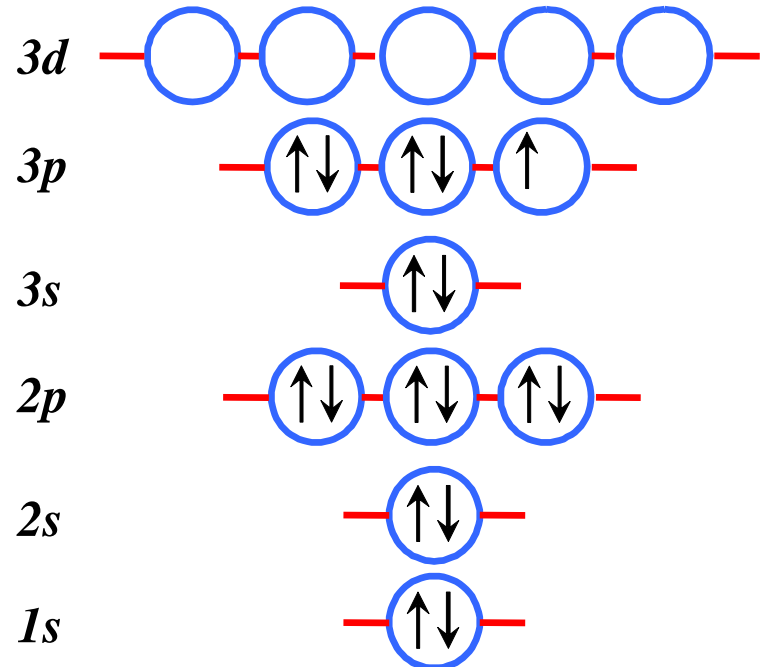
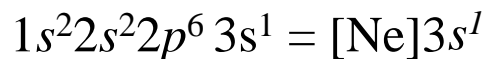

$Z = 17$ Cl

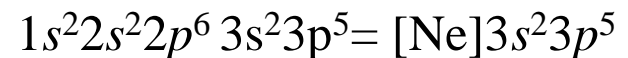

Legame Ionico

Legame di natura *elettrostatica* che si forma tra un *elemento* con bassa energia di ionizzazione (**metallo**) ed un *elemento* con un alta affinità elettronica (non-metallo)

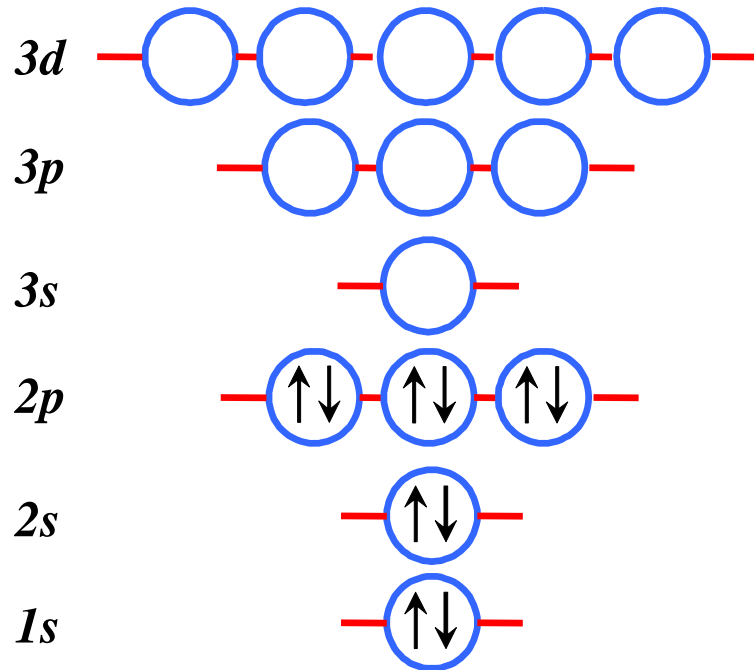

$Z = 11$ Na^+

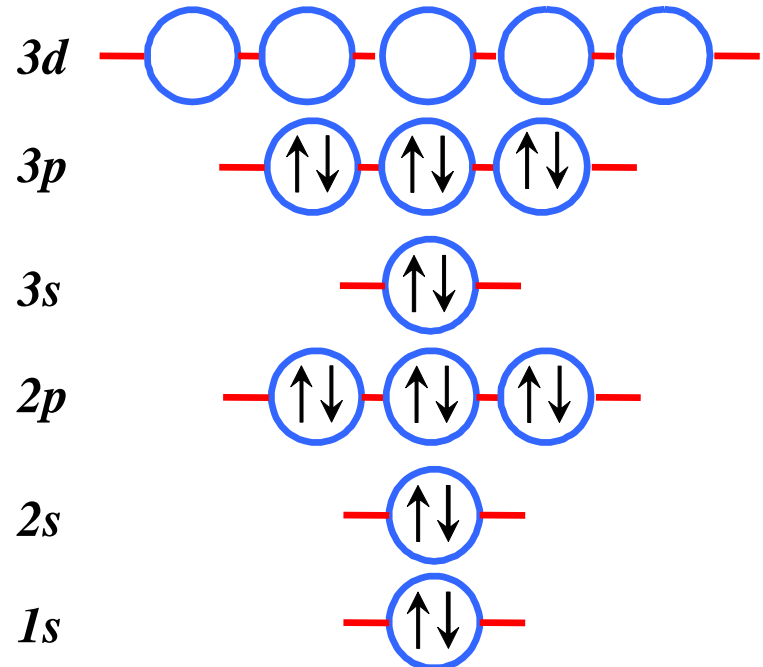
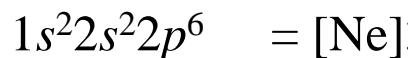

$Z = 17$ Cl^-

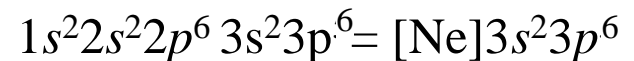

$$I_I(\text{Na}) = 496 \text{ kJ/mol} \quad R_i(\text{Na}^+) = 102 \text{ pm}$$

$$A_e(\text{Cl}) = 349 \text{ kJ/mol} \quad R_i(\text{Cl}^-) = 181 \text{ pm}$$

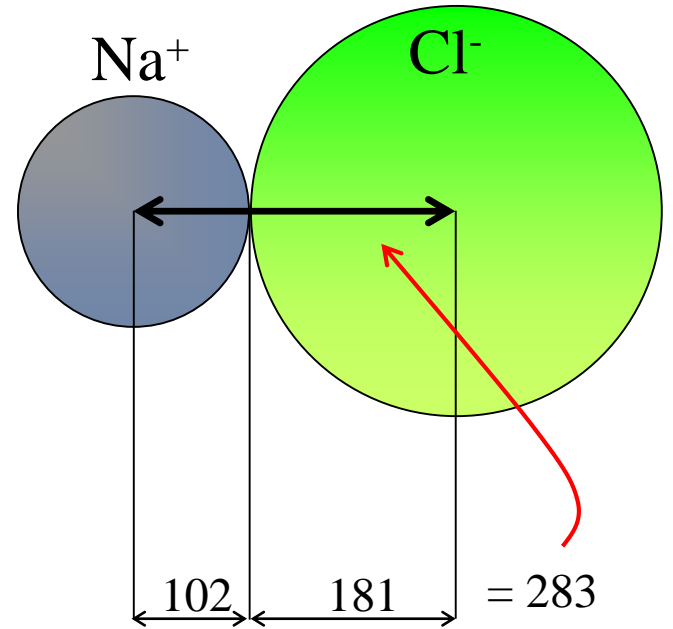

$$E = E_{Coul}(\text{Na}^+\text{Cl}^-) + I_I(\text{Na}) - A_e(\text{Cl})$$

$$E_{Coul} = \frac{1}{4\pi\epsilon_0} \cdot \frac{q_{Na} \cdot q_{Cl}}{r}$$

$$= \frac{1}{4\pi \cdot 8.86 \cdot 10^{-12}} \cdot \frac{(1.6 \cdot 10^{-19}) \cdot (-1.6 \cdot 10^{-19})}{283 \cdot 10^{-12}} = \frac{-2.56 \cdot 10^{-38}}{31508.7 \cdot 10^{-24}} = -8.12 \cdot 10^{-19} \text{ J}$$

$\times N_A$ (numero di Avogadro) ottengo J/mol

$$-8.12 \cdot 10^{-19} \times 6.02 \cdot 10^{23} = -48.8 \cdot 10^4 \text{ J/mol} = -488 \text{ kJ/mol}$$

$$E = -488 + 496 - 349 = -341 \text{ kJ/mol}$$

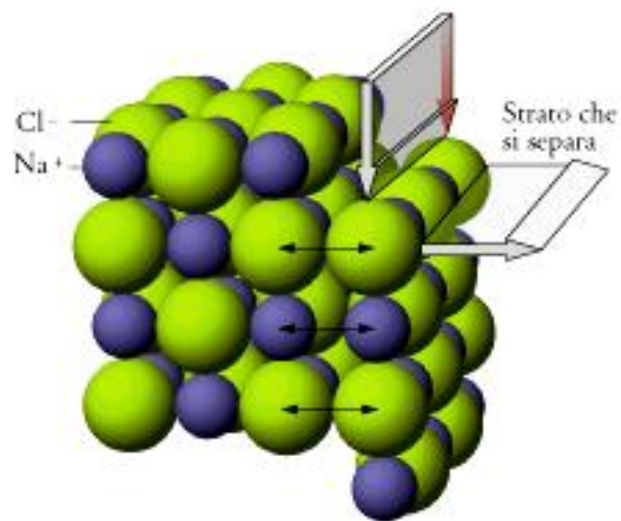
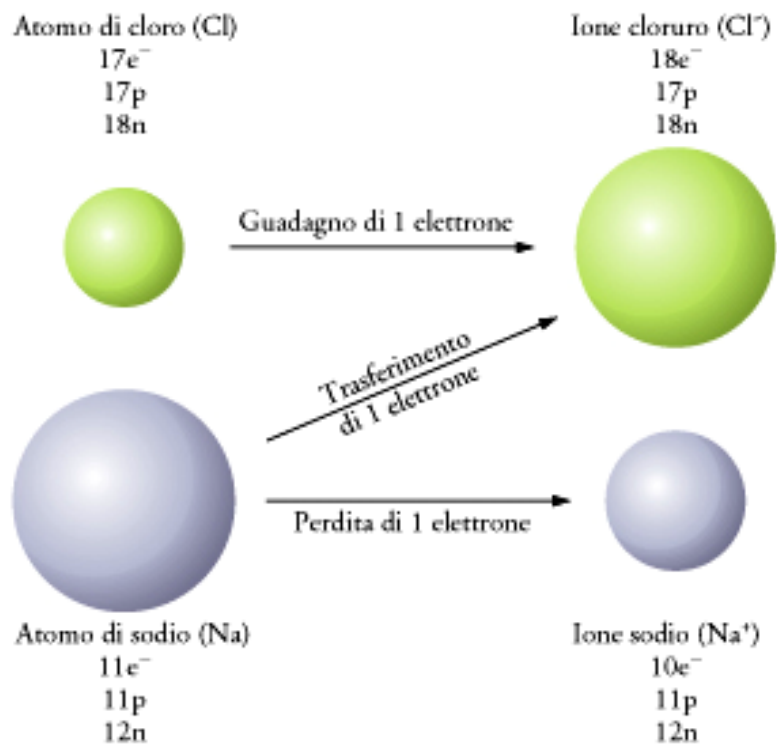

(a)



(b)

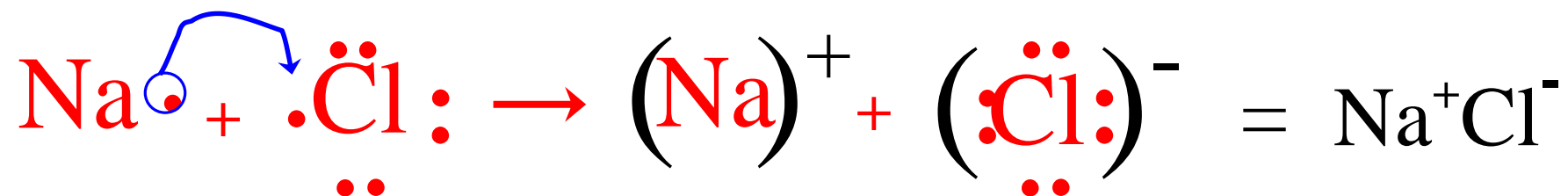

Legame Covalente

Lewis (1916): il **legame covalente** è dovuto alla condivisione tra due atomi di una o più coppie di elettroni, chiamate *coppie elettroniche di legame*, in modo che ciascun atomo raggiunga la configurazione (elettronica) di gas nobile.

Omeopolare o omonucleari

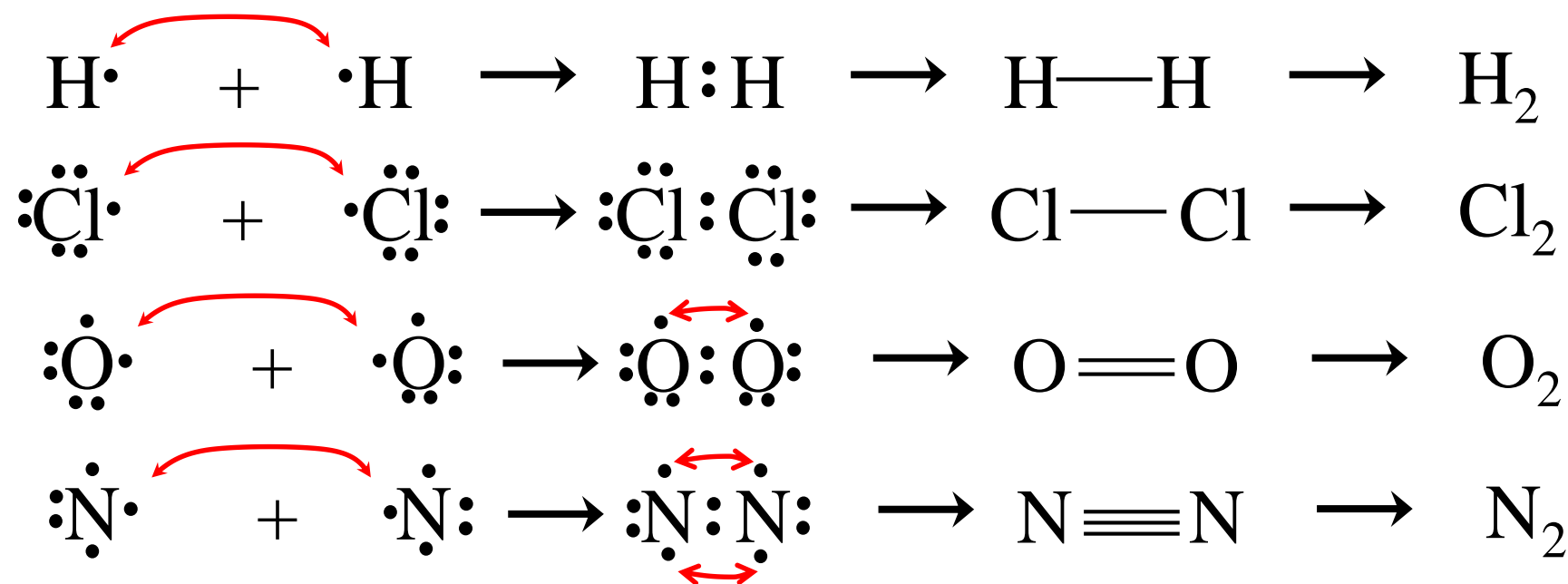

Legame Covalente *Eteropolare o eteronucleari*

Nei simboli di Lewis usiamo indifferentemente \cdot oppure $|$ per rappresentare la coppia di elettroni

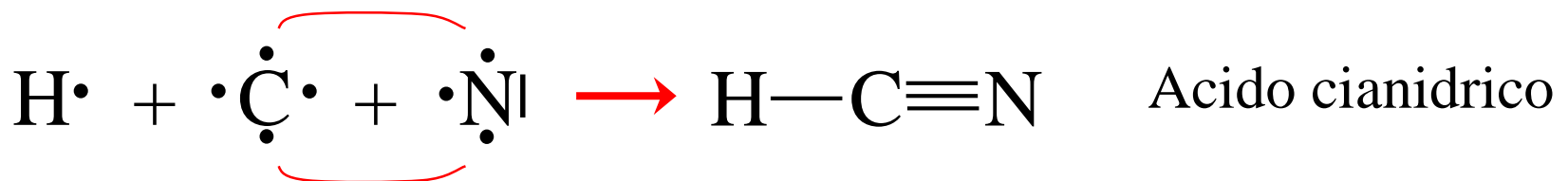
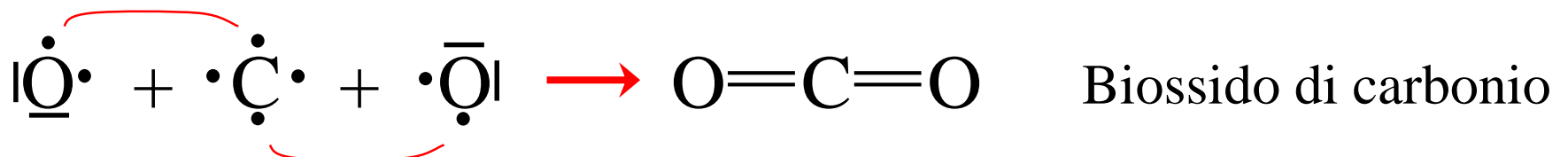
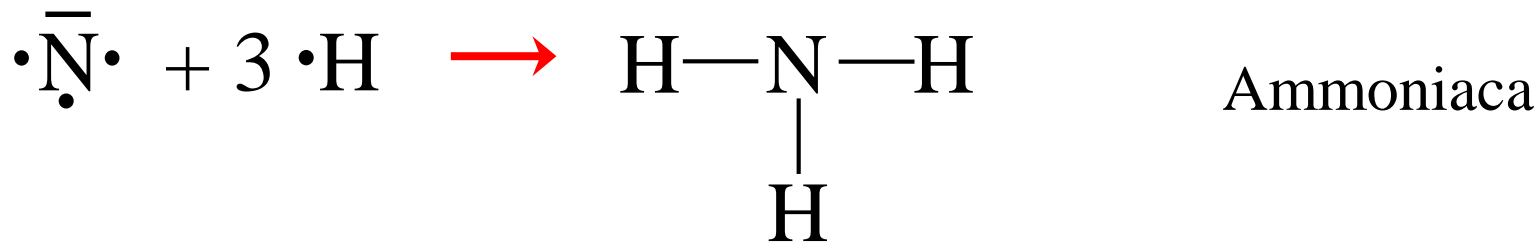

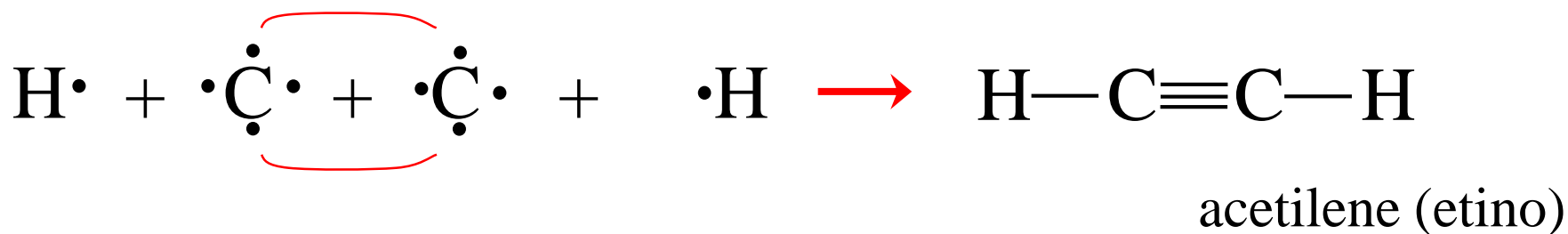
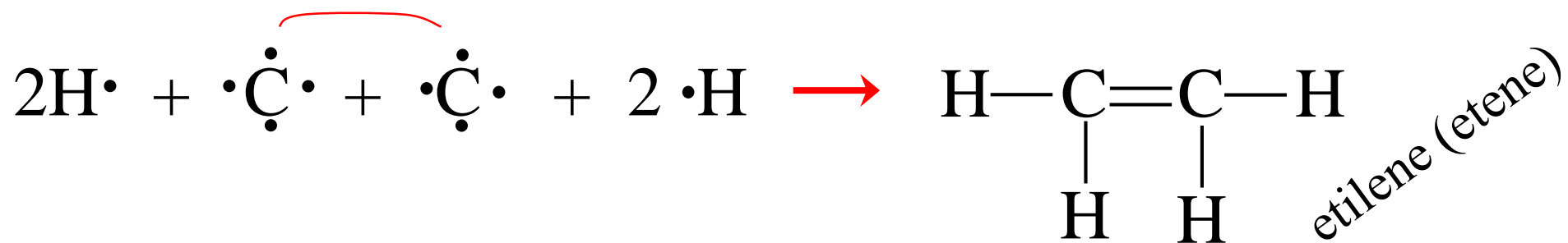
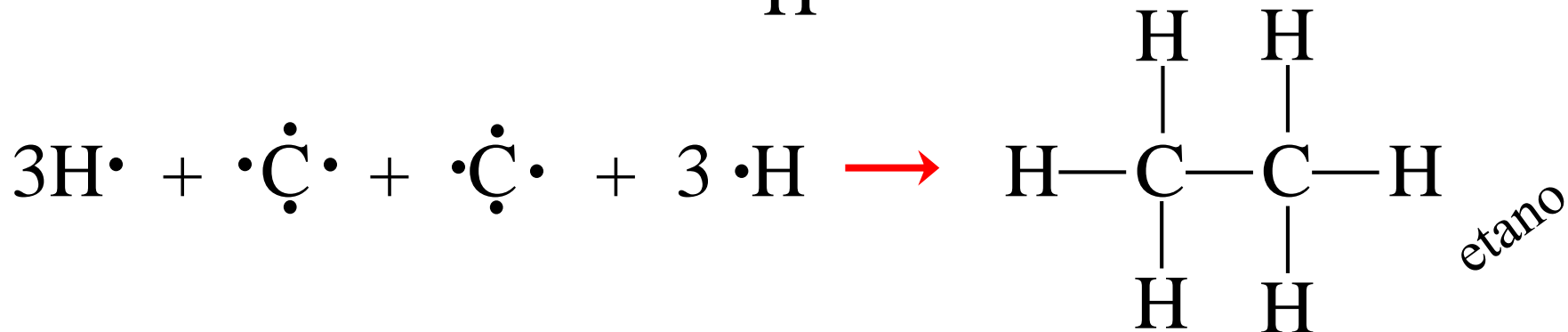
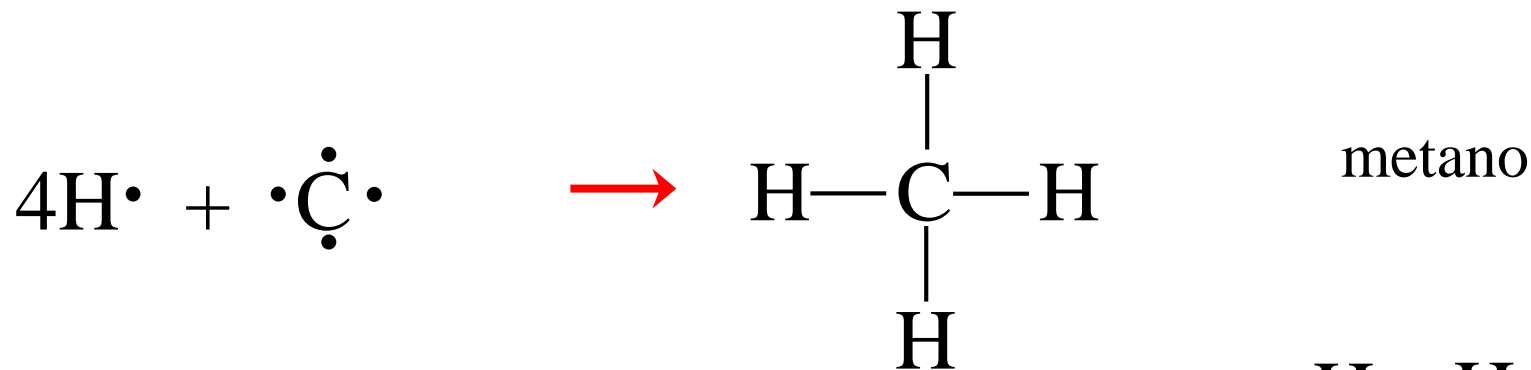

Legame Covalente *Dativo o di coordinazione*

In questo caso la coppia elettronica è messa a disposizione da un solo atomo (*donatore*). L'altro atomo (*accettore*) ha un orbitale vuoto dove riceve la coppia elettronica di legame

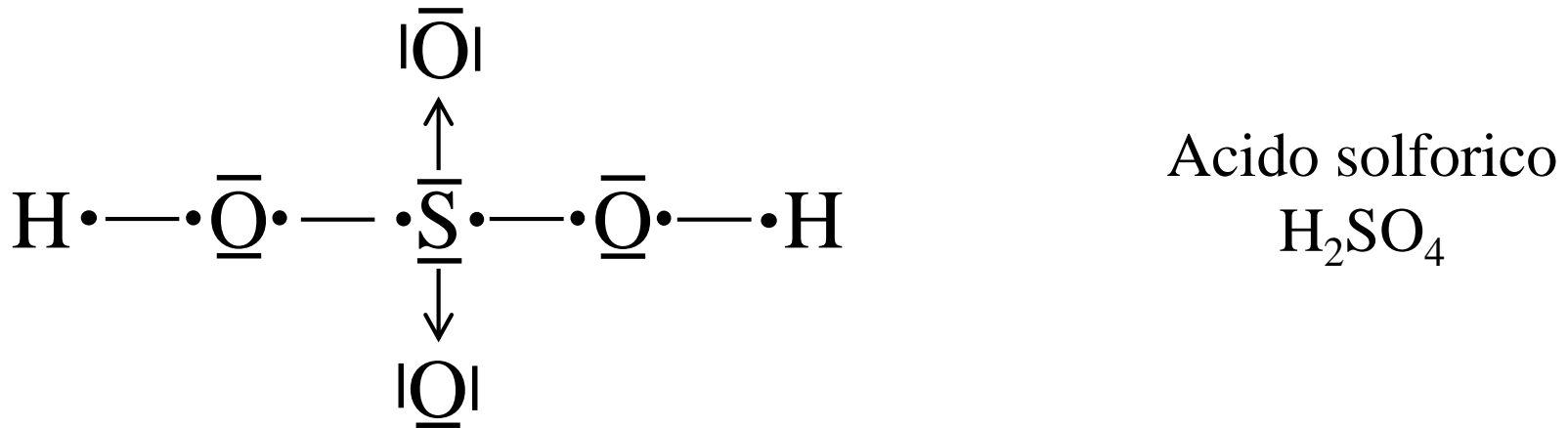
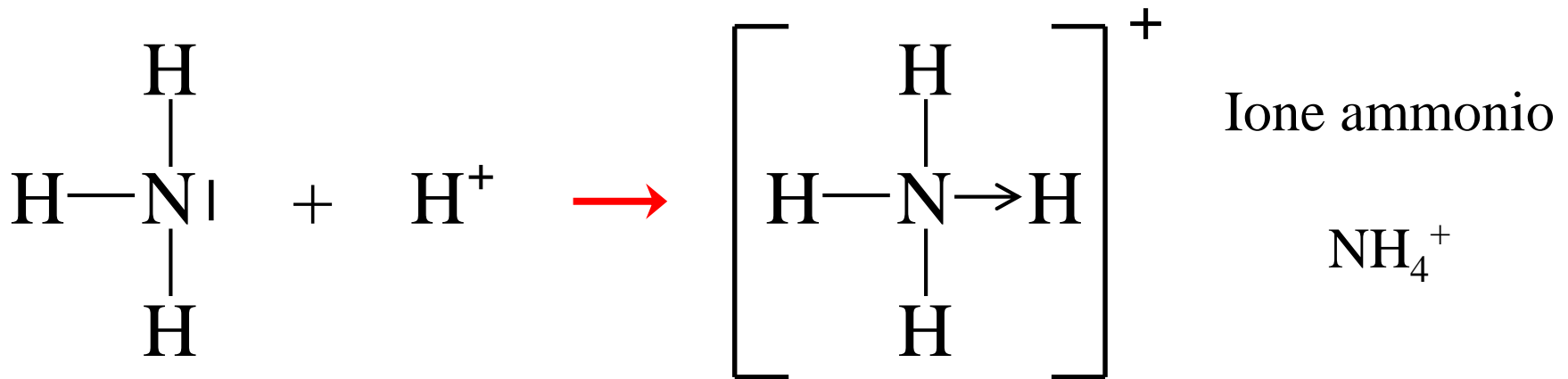

Eccezioni alla regola dell'ottetto

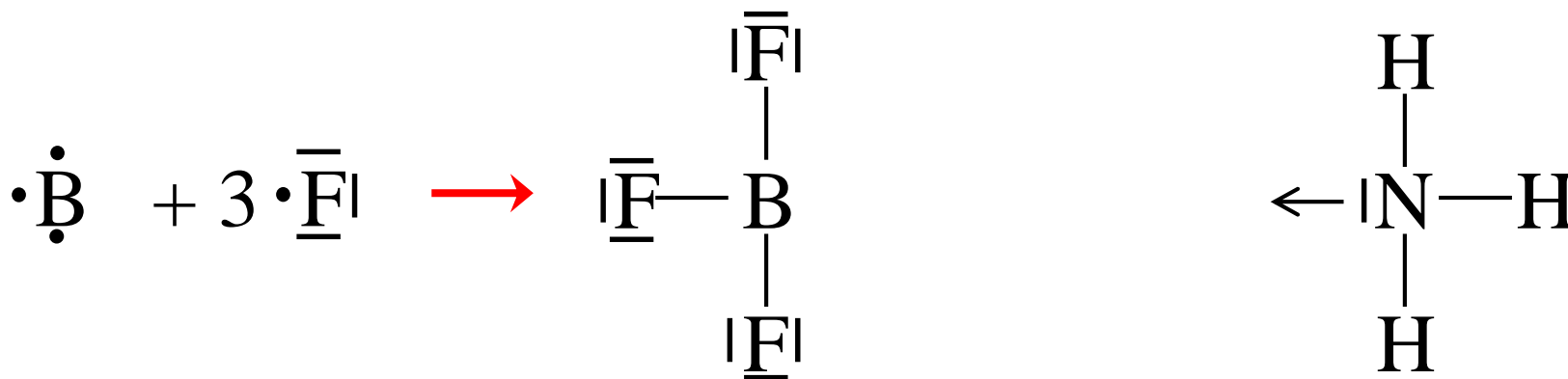
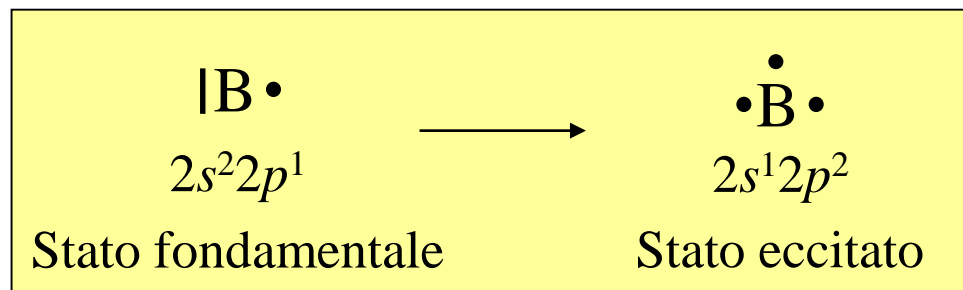

Forma un *addotto*

Definizione di acido e base di Lewis

Eccezioni alla regola dell'ottetto

(*espansione della sfera di valenza*)

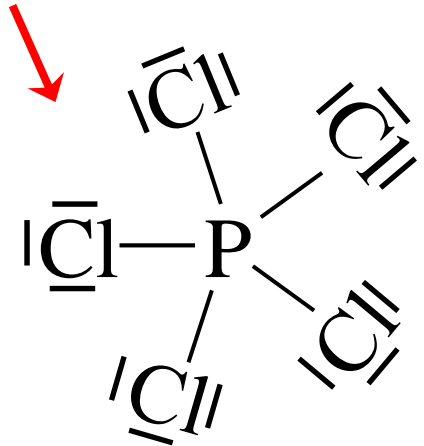
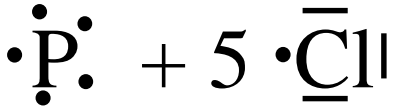
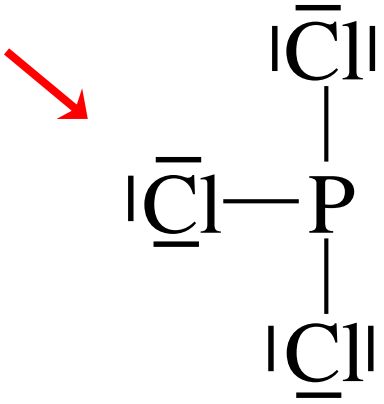
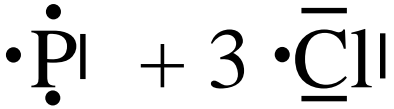
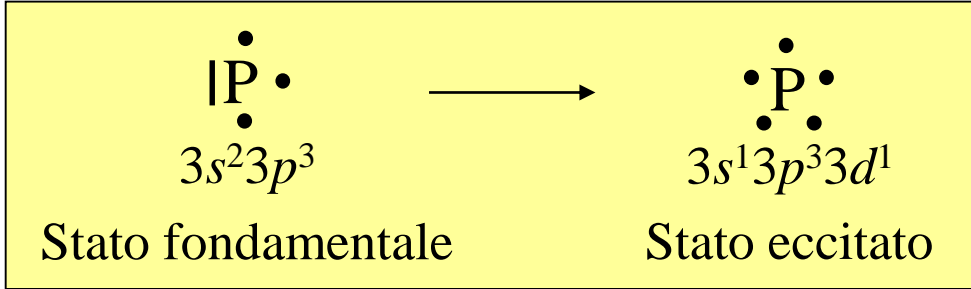

(*espansione della sfera di valenza per lo Zolfo*)

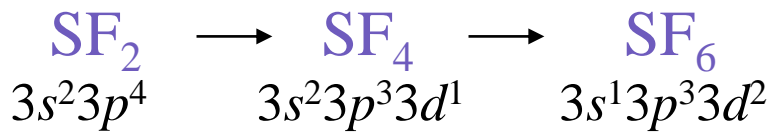

Eccezioni alla regola dell'ottetto

(*espansione della sfera di valenza*)

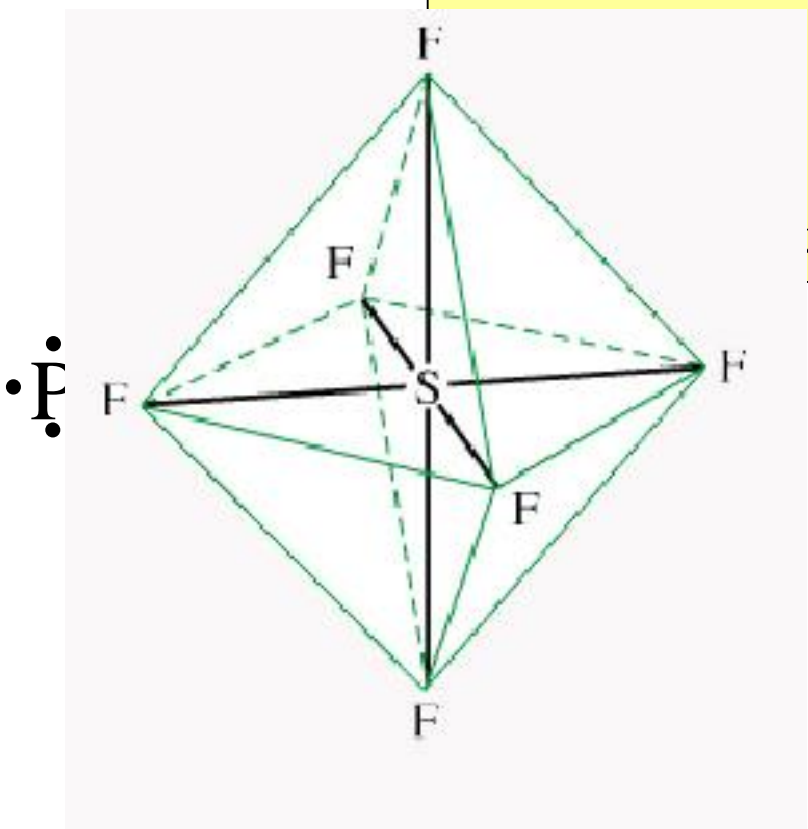

ale

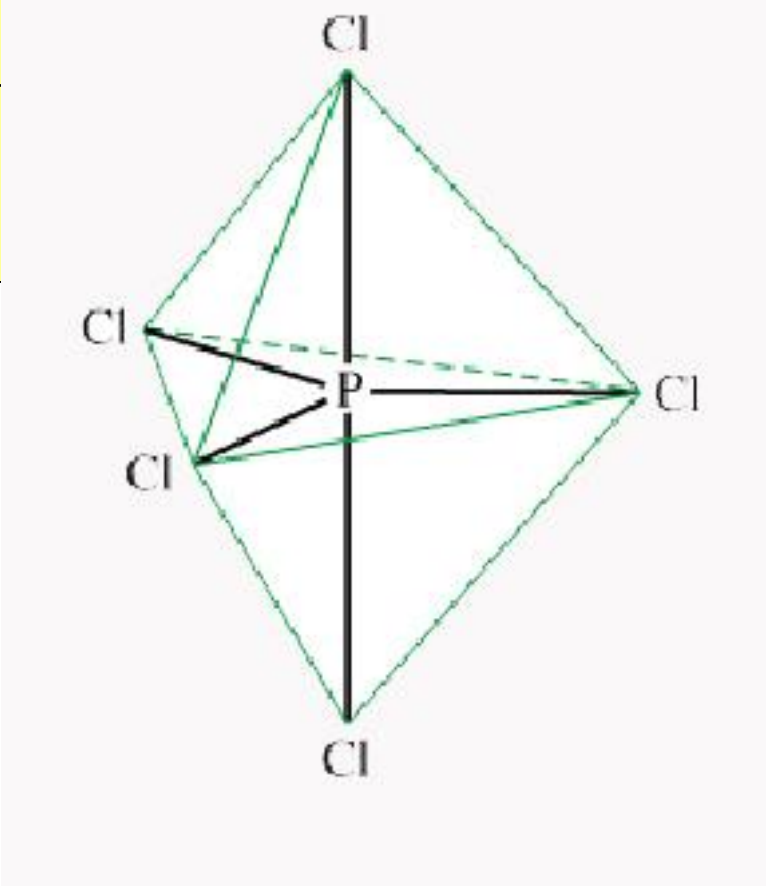

(*espansione della sfera di valenza per lo Zolfo*)

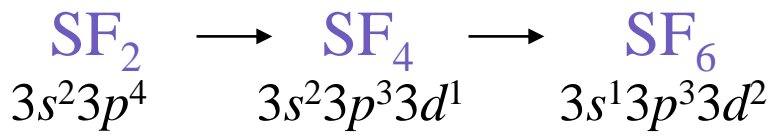

Energia di Dissociazione dei legami, valori medi di alcuni legami singoli in *kJ/mol*

	H	C	N	O	P	Cl
H	436	414	389	464	318	431
C		347	293	351	264	330
N			159	201	209	201
O				138	351	205
P					213	331
Cl						243

Legami doppi e tripli

C=C	611	C=O	803
C≡C	837	C≡O	1075
N=N	418	C=N	615
N≡N	946	C≡N	891

Lunghezza di alcuni legami singoli in picometri (pm)

	H	C	N	O	P	Cl
H	74	110	98	94	138	127
C		154	147	143	187	176
N			140	136	180	169
O				132	176	165
P					220	209
Cl						200

picometri - $1 \text{ pm} = 10^{-12} \text{ m}$

Lunghezza di alcuni legami doppi e tripli

$\text{C}=\text{C}$	134	$\text{C}\equiv\text{C}$	121
$\text{C}=\text{O}$	122	$\text{C}\equiv\text{O}$	113
$\text{C}=\text{N}$	127	$\text{C}\equiv\text{N}$	115

Legame Covalente-Polare

In una molecola due atomi di elementi diversi legati tra loro avranno una diversa capacità di attrarre i due elettroni di legame.

La coppia di elettroni impiegherà più tempo vicino al nucleo che ha una maggiore forza di attrazione.

In media nel tempo si vede un eccesso di carica negativa ($-\delta$) sull'atomo con maggiore forza di attrazione sugli elettroni e positiva ($+\delta$) sull'altro.

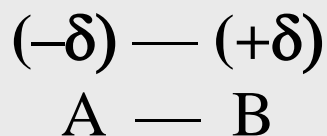

$$\mu = \delta \cdot l$$

μ = momento di dipolo

δ = eccesso di carica

l = lunghezza del legame

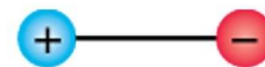

(a)

dipolo elettrico



(b)

vettore μ

μ viene misurato in Debey (D)

$$1 \text{ D} = 3.33 \cdot 10^{-30} \text{ C m}$$

Dalla misura di μ e della distanza di legame l si può risalire al valore di δ che da un'indicazione formale di *percentuale di carattere ionico* del legame covalente

Ad es. per H-Cl

$$\mu = 1.06 \text{ D} = 1.06 \cdot 3.34 \cdot 10^{-30} = 3.5404 \cdot 10^{-30} \text{ C}\cdot\text{m}$$

ed

$$l = 127 \text{ pm} = 1.27 \cdot 10^{-10} \text{ m}$$

$$q = \frac{\mu}{l} = \frac{3.5404 \cdot 10^{-30} \text{ C}\cdot\text{m}}{127 \cdot 10^{-12} \text{ m}} = 2.788 \cdot 10^{-20} \text{ C}$$

$$q(e) = \frac{2.788 \cdot 10^{-20} \text{ C}}{1.602 \cdot 10^{-19} \text{ C}} = 0.174$$

$$\% = \frac{\mu}{e \cdot l} 100$$

Acido alogenidrico	$\mu(\text{D})$	$\Delta\chi$	Caratt. ionico (%)
HF	1,98	1,9 (4,0-2,1)	45
HCl	1,06	0,9 (3,0-2,1)	17
HBr	0,79	0,7 (2,8-2,1)	12
HI	0,38	0,4 (2,5-2,1)	5

Legame covalente-polare negli acidi alogenidrici

HX (X = F, Cl, Br e I).

In una molecola, la capacità di un atomo di addensare su di sé gli elettroni di legame viene indicata con ***elettronegatività***.

Una stima dell'*elettronegatività* viene dalla *densità elettronica* nell'atomo. - Tanto maggiore è la *densità* tanto maggiore sarà la forza di attrazione che il nucleo esercita sugli elettroni.

Quando in un legame gli elettroni tendono a spostarsi verso l'atomo più elettronegativo, allora la densità elettronica di quest'ultimo tende a diminuire, a causa della maggiore repulsione tra gli elettroni, mentre in quello meno elettronegativo tende ad aumentare, raggiungendo così valori uguali, un equilibrio, tra i due atomi.

Pauling ha trovato una relazione empirica che permette di ottenere valori di *elettronegatività* che presentano la proprietà di essere additivi.

$$\left| \chi_A - 2.1 \right| = 0.10 \sqrt{\Delta}$$

dove:

χ_A = elettronegatività

Δ = la differenza di energia di legame tra la media geometrica delle energie di *legame omeopolari* e quella del *legame in questione*.

Energia di Dissociazione dei legami, valori medi di alcuni legami singoli in *kJ/mol*

	H	C	N	O	P	Cl
H	436	414	389	464	318	431
C		347	293	351	264	330
N			159	201	209	201
O				138	351	205
P					213	331
Cl						243

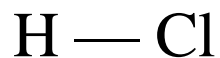

$H_2 = 436$
 $Cl_2 = 243$
 $HCl = 431$

$$\Delta = 431 - (436 + 243)/2 = 431 - 339.5$$

$$\Delta = 91.5$$

$$|\chi_{Cl} - 2.1| = 0.10 \sqrt{91.5} = 0.96$$

$$\chi_{Cl} = 0.96 + 2.1 = 3.06$$

1	2	13	14	15	16	17
H						
2,2						
Li	Be	B	C	N	O	F
1,0	1,6	2,0	2,6	3,0	3,4	4,0
Na	Mg	Al	Si	P	S	Cl
0,9	1,3	1,6	1,9	2,2	2,6	3,0
K	Ca	Ga	Ge	As	Se	Br
0,8	1,0	1,8	2,0	2,2	2,6	2,8
Rb	Sr	In	Sn	Sb	Te	I
0,8	1,0	1,8	2,0	2,1	2,1	2,5
Cs	Ba	Tl	Pb	Bi		
0,8	0,9	2,0	2,0	2,0		
Elementi di transizione 3d: 1,4-1,9						
Elementi di transizione 4d: 1,2-2,3						
Elementi di transizione 5d: 1,1-2,5						
Elementi di transizione interna 4f: 1,1-1,3						

Elettronegatività degli atomi
dei gruppi principali secondo
Pauling.

1 H 2,1											<div style="display: flex; justify-content: space-around;"> <div style="text-align: center;"> <1,0 </div> <div style="text-align: center;"> 2,0-2,4 </div> </div>							
3 Li 1,0	4 Be 1,5											<div style="display: flex; justify-content: space-around;"> <div style="text-align: center;"> 1,0-1,4 </div> <div style="text-align: center;"> 2,5-2,9 </div> </div>		5 B 2,0	6 C 2,5	7 N 3,0	8 O 3,5	9 F 4,0
11 Na 1,0	12 Mg 1,2											13 Al 1,5	14 Si 1,8	15 P 2,1	16 S 2,5	17 Cl 3,0		
19 K 0,9	20 Ca 1,0	21 Sc 1,3	22 Ti 1,4	23 V 1,5	24 Cr 1,6	25 Mn 1,6	26 Fe 1,7	27 Co 1,7	28 Ni 1,8	29 Cu 1,8	30 Zn 1,6	31 Ga 1,7	32 Ge 1,9	33 As 2,1	34 Se 2,4	35 Br 2,8		
37 Rb 0,9	38 Sr 1,0	39 Y 1,2	40 Zr 1,3	41 Nb 1,5	42 Mo 1,6	43 Tc 1,7	44 Ru 1,8	45 Rh 1,8	46 Pd 1,8	47 Ag 1,6	48 Cd 1,6	49 In 1,6	50 Sn 1,8	51 Sb 1,9	52 Te 2,1	53 I 2,5		
55 Cs 0,8	56 Ba 1,0	57 La 1,1	72 Hf 1,3	73 Ta 1,4	74 W 1,5	75 Re 1,7	76 Os 1,9	77 Ir 1,9	78 Pt 1,8	79 Au 1,9	80 Hg 1,7	81 Tl 1,6	82 Pb 1,7	83 Bi 1,8	84 Po 1,9	85 At 2,1		
87 Fr 0,8	88 Ra 1,0	89 Ac 1,1																

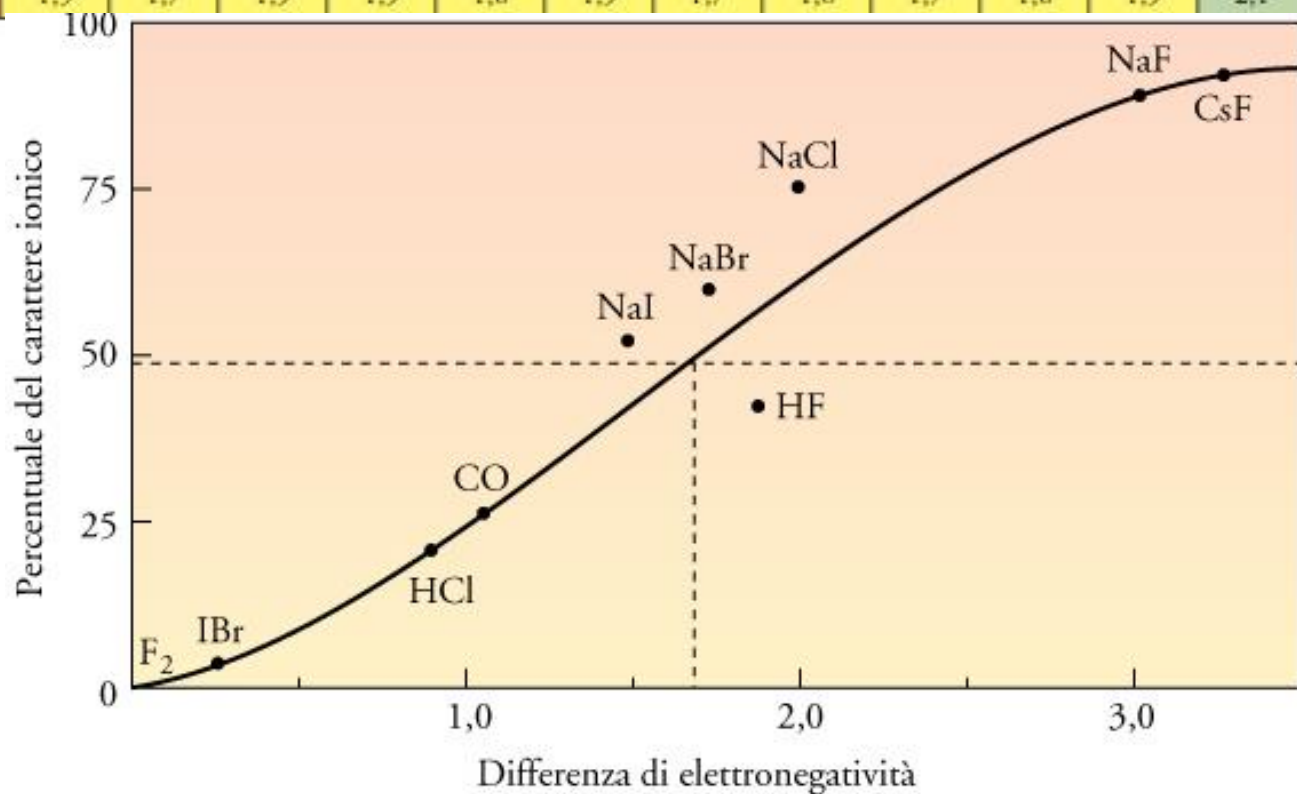

1 H 2,1																	
3 Li 1,0	4 Be 1,5																
11 Na 1,0	12 Mg 1,2																
19 K 0,9	20 Ca 1,0	21 Sc 1,3	22 Ti 1,4	23 V 1,5	24 Cr 1,6	25 Mn 1,6	26 Fe 1,7	27 Co 1,7	28 Ni 1,8	29 Cu 1,8	30 Zn 1,6	31 Ga 1,7	32 Ge 1,9	33 As 2,1	34 Se 2,4	35 Br 2,8	
37 Rb 0,9	38 Sr 1,0	39 Y 1,2	40 Zr 1,3	41 Nb 1,5	42 Mo 1,6	43 Tc 1,7	44 Ru 1,8	45 Rh 1,8	46 Pd 1,8	47 Ag 1,6	48 Cd 1,6	49 In 1,6	50 Sn 1,8	51 Sb 1,9	52 Te 2,1	53 I 2,5	
55 Cs 0,8	56 Ba 1,0	57 La 1,1	72 Hf 1,3	73 Ta 1,4	74 W 1,5	75 Re 1,7	76 Os 1,9	77 Ir 1,9	78 Pt 1,8	79 Au 1,9	80 Hg 1,7	81 Tl 1,6	82 Pb 1,7	83 Bi 1,8	84 Po 1,9	85 At 2,1	
87 Fr 0,8	88 Ra 1,0	89 Ac 1,1															

Nei composti nei quali gli elementi hanno differenza di *elettronegatività*:

$$|\chi(\text{el}_1) - \chi(\text{el}_2)| \geq 2.0 \quad \text{composti ionici}$$

$$2 > |\chi(\text{el}_1) - \chi(\text{el}_2)| > 0.4 \quad \text{composti covalenti-polari}$$

$$|\chi(\text{el}_1) - \chi(\text{el}_2)| \approx 0.4 \quad \text{composti covalenti}$$

Molecola triatomica

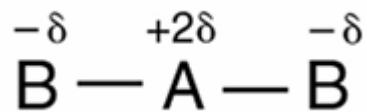

a) lineare

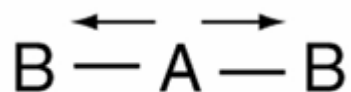

$$\Sigma \mu_i = 0$$

b) ad angolo

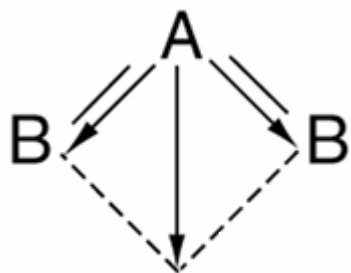

$$\Sigma \mu_i \neq 0$$

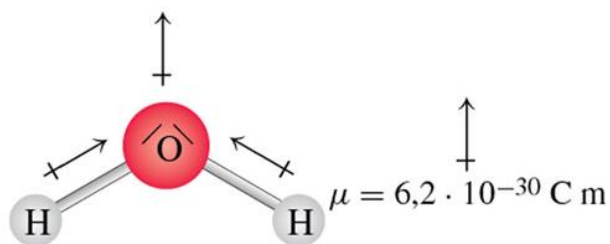
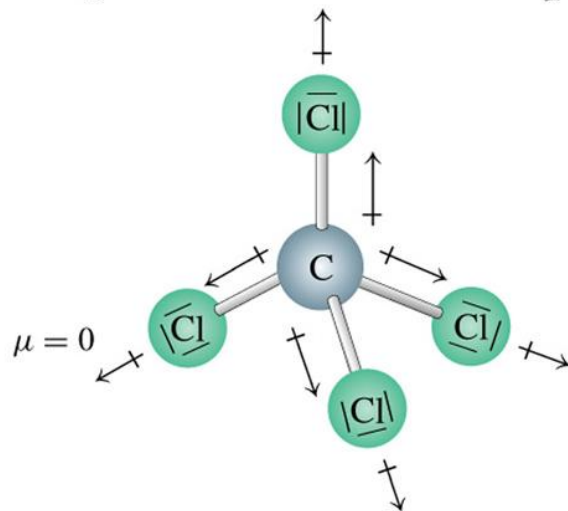
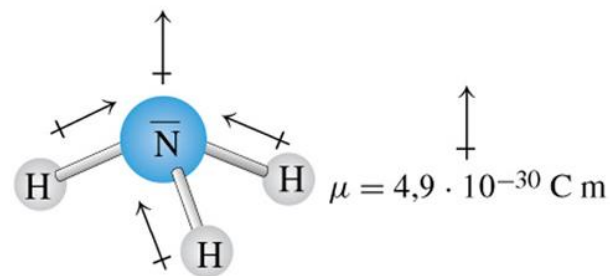
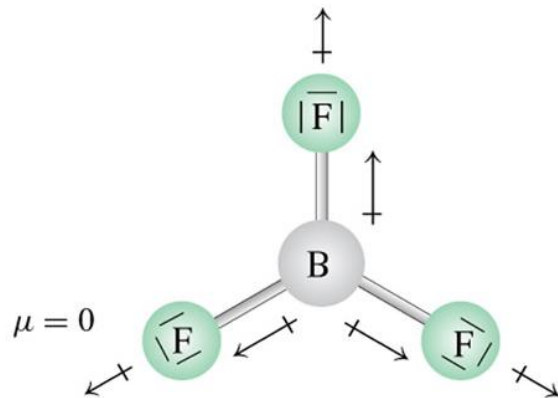
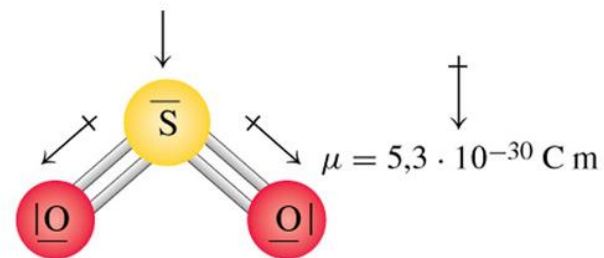
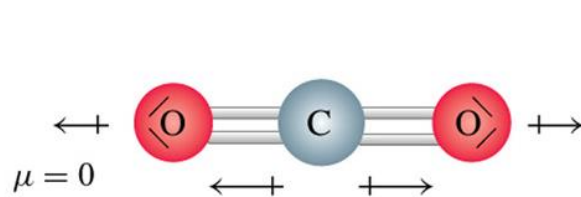

Geometria Molecolare - VSEPR

VSEPR = Valence Shell Electron Pair Repulsion

L'ipotesi di base è che *la disposizione geometrica dei legami attorno ad un atomo dipende dal numero totale di coppie elettroniche, di legame e solitarie, che lo circondano.*

Le coppie elettroniche si dispongono nello spazio (il più lontano possibile) in modo da minimizzare la loro repulsione.

a) Disegnare la struttura di Lewis – stabilire il numero di coppie elettroniche (di legame e non). I legami multipli contribuiscono con una sola coppia.

b) Disporre le coppie il più lontano possibile tra di loro sulla superficie di una sfera.
(ad ogni numero di coppie corrisponde una delle seguenti geometrie.)

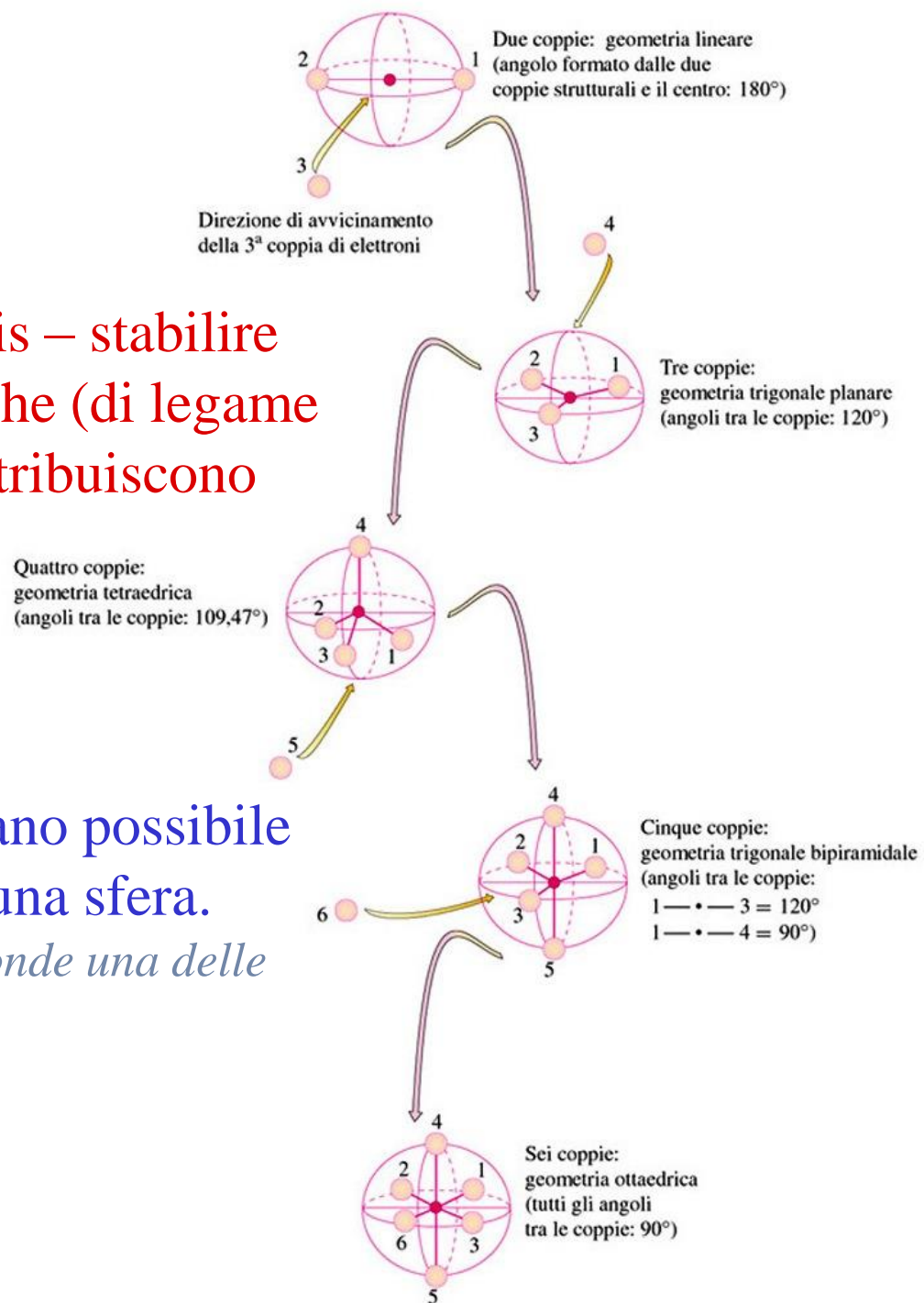

Numero
coppie
elettroniche

2

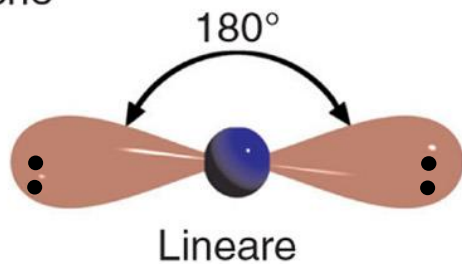

3

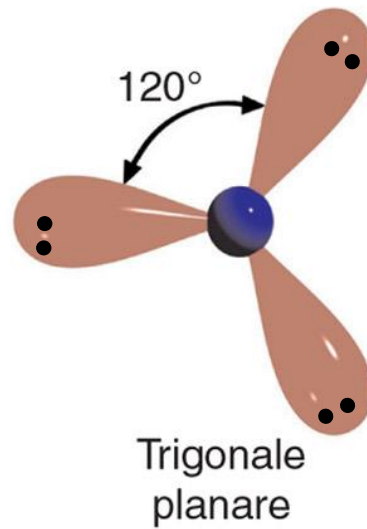

4

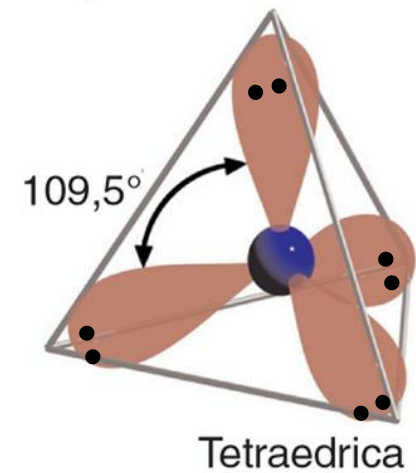

5

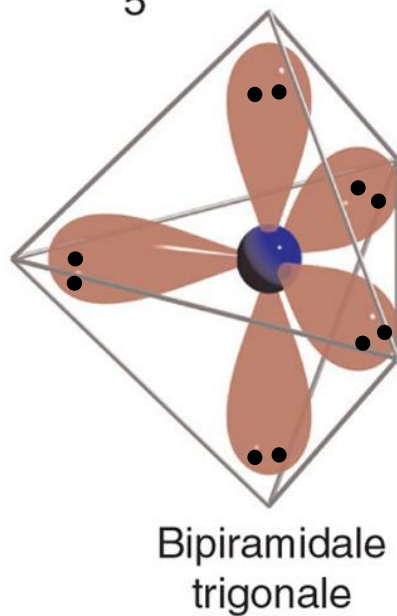

6

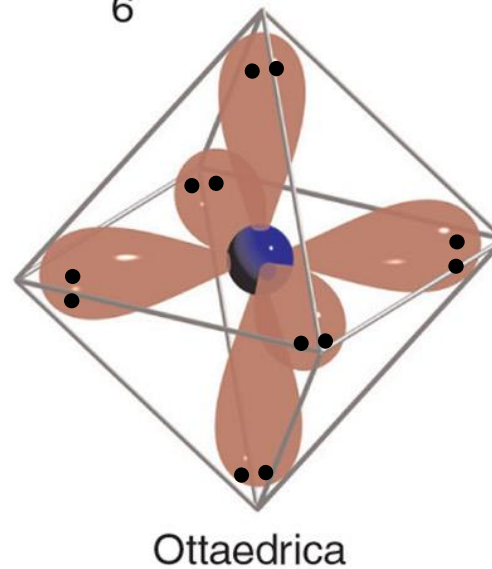

	Formula di Lewis	N. totale di coppie	Disposizione coppie	N. coppie solitarie	Forma prevista	Angolo previsto
BeH ₂	H — Be — H	2	lineare	0	H — Be — H lineare	180°
CO ₂	O = C = O	2	lineare	0	O = C = O lineare	180°
BF ₃	$\begin{array}{c} \text{F} - \text{B} - \text{F} \\ \\ \text{F} \end{array}$	3	trigonale planare	0	$\begin{array}{c} \text{F} \quad \quad \text{F} \\ \quad \backslash \quad / \\ \quad \quad \text{B} \\ \quad \quad \\ \quad \quad \text{F} \end{array}$ trigonale planare	120°
SO ₂	O = $\overset{\cdot\cdot}{\text{S}}$ = O			1	$\begin{array}{c} \quad \quad \cdot\cdot \\ \quad \quad \text{S} \\ \quad // \quad \backslash \\ \text{O} \quad \quad \text{O} \end{array}$ angolare	≈ 120°

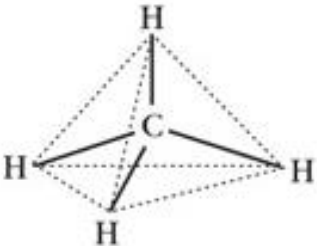
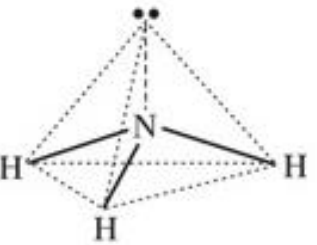
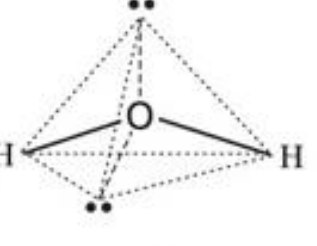
CH_4	$\begin{array}{c} \text{H} \\ \\ \text{H}-\text{C}-\text{H} \\ \\ \text{H} \end{array}$	4	tetraedrica	0	 <p style="text-align: center;">tetraedrica</p>	$109,5^\circ$
NH_3	$\begin{array}{c} \cdot\cdot \\ \\ \text{H}-\text{N}-\text{H} \\ \\ \text{H} \end{array}$			1	 <p style="text-align: center;">piramidale trigonale</p>	$< 109,5^\circ$ $(107,5^\circ)$
H_2O	$\begin{array}{c} \cdot\cdot \\ \\ \text{H}-\text{O}-\text{H} \\ \cdot\cdot \end{array}$			2	 <p style="text-align: center;">angolare</p>	$\ll 109,5^\circ$ $(104,5^\circ)$
HCl	$\begin{array}{c} \cdot\cdot \\ \\ \text{H}-\text{Cl} \\ \cdot\cdot \end{array}$			3	$\begin{array}{c} \cdot\cdot \\ \\ \text{H}-\text{Cl} \\ \cdot\cdot \end{array}$	

Teoria del Legame di Valenza (Valence Bond)

Interpreta il legame a coppia di elettroni di Lewis in termini della Meccanica ondulatoria, ed introduce una funzione d'onda, Ψ_{cov} per descrivere la coppia di elettroni.

La formazione del legame implica secondo la VB

- 1) Gli orbitali atomici che si sovrappongono devono avere energie poco diverse
- 2) Ognuno dei due atomi deve contribuire con orbitali che descrivano un solo elettrone – *modificare nel DATIVO*
- 3) La direzione di massima sovrapposizione degli orbitali corrisponde alla direzione del legame

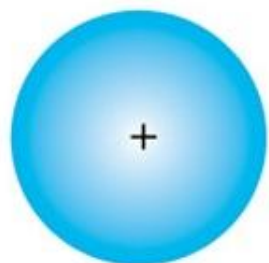

1s

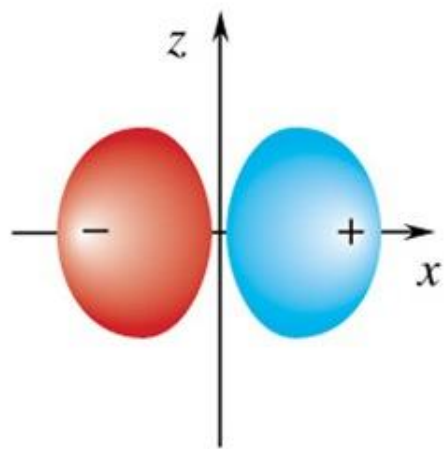

$2p_x$

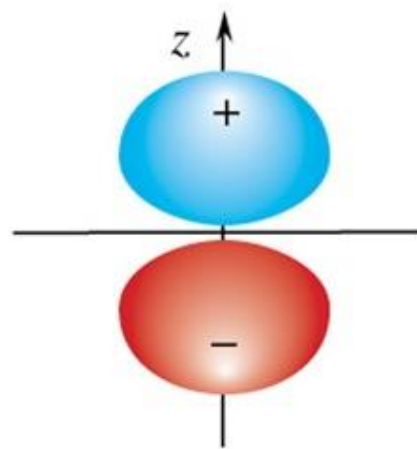

$2p_z$

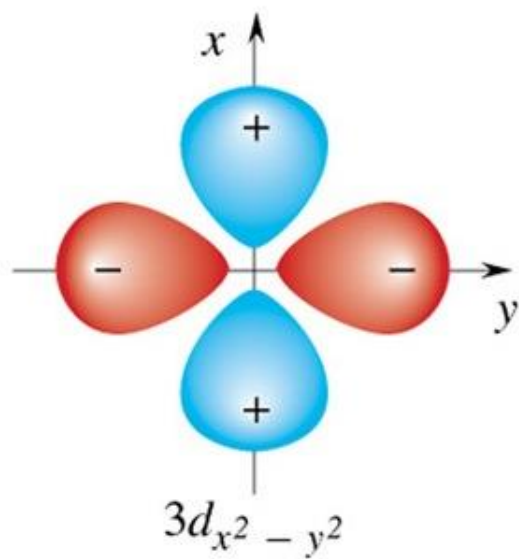

$3d_{x^2-y^2}$

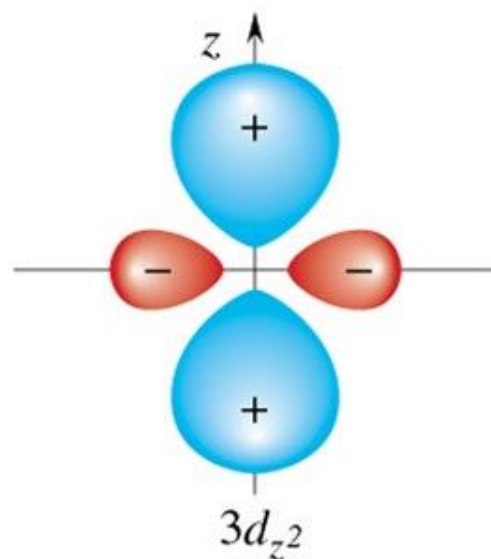

$3d_{z^2}$

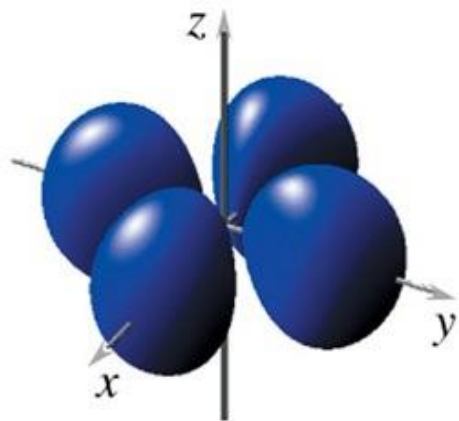

$$3d_{x^2 - y^2}$$

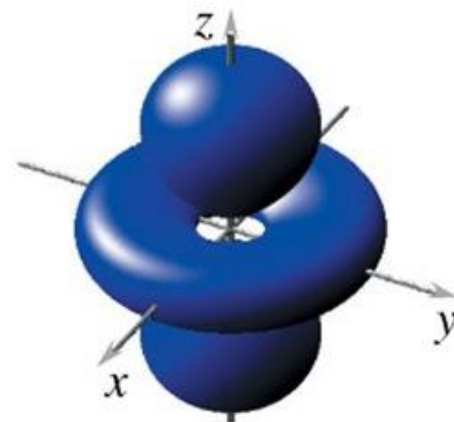

$$3d_{z^2}$$

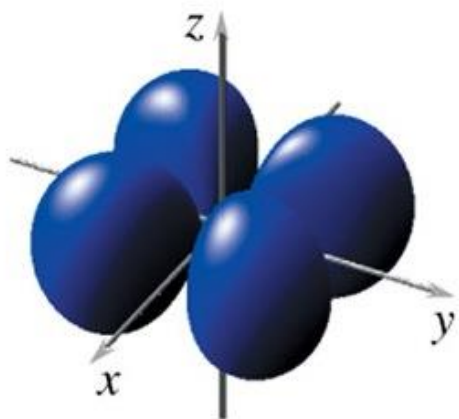

$$3d_{xy}$$

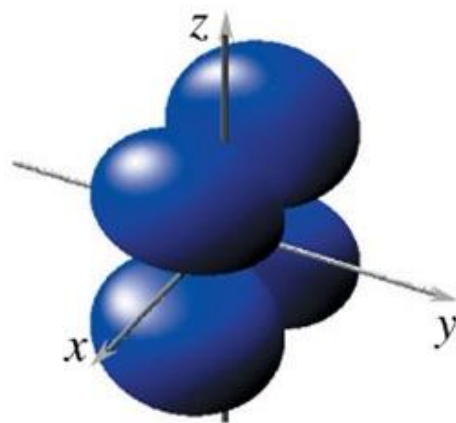

$$3d_{xz}$$

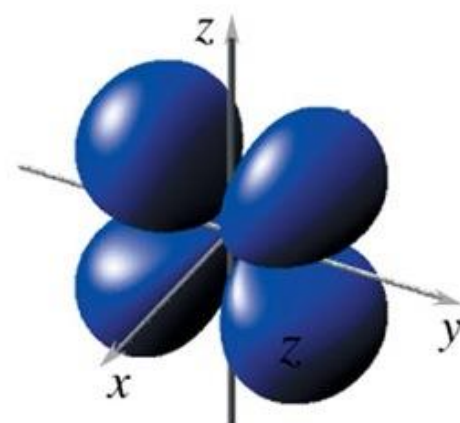

$$3d_{yz}$$

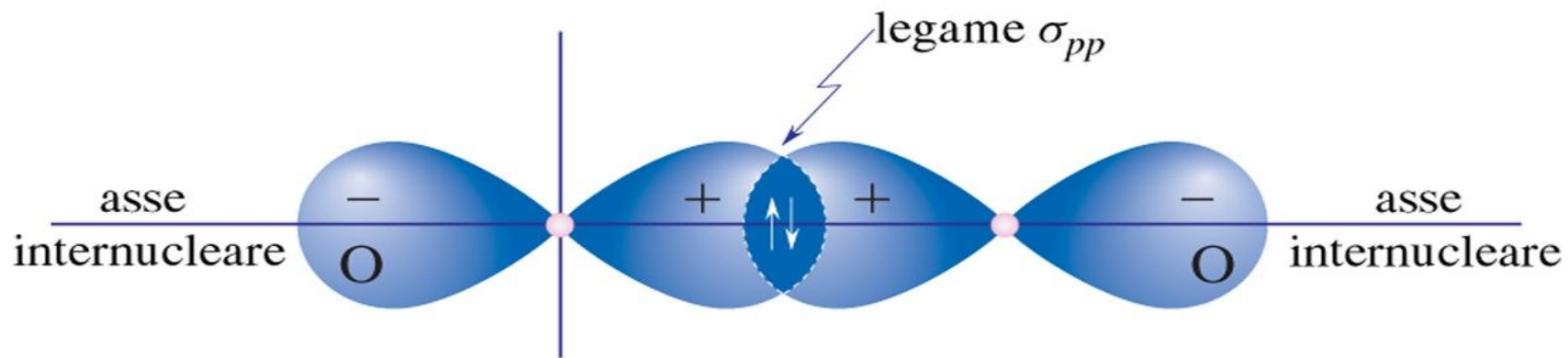
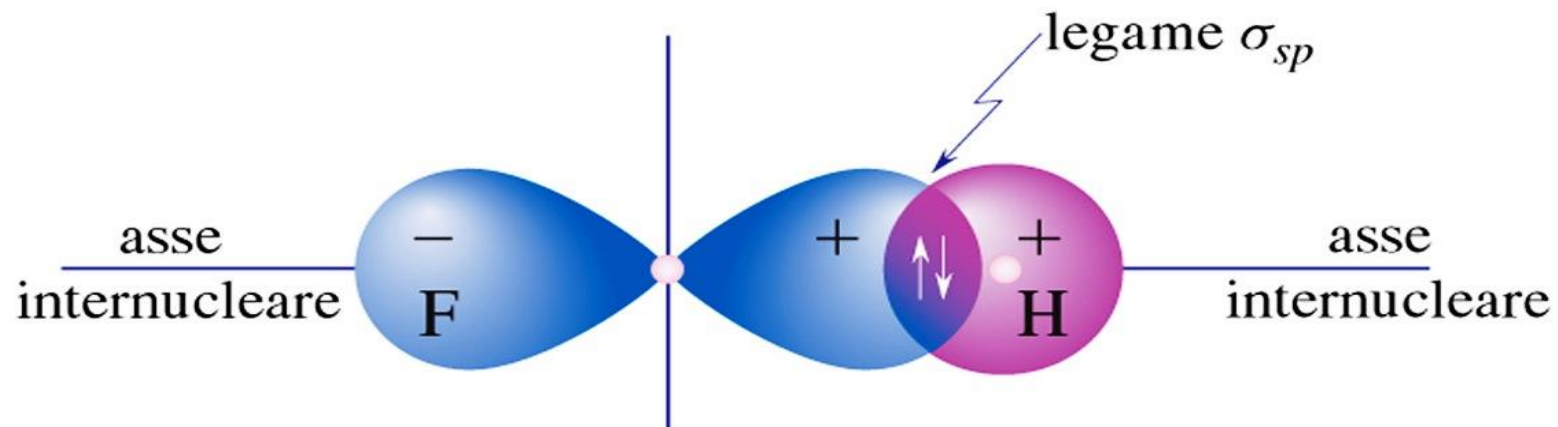
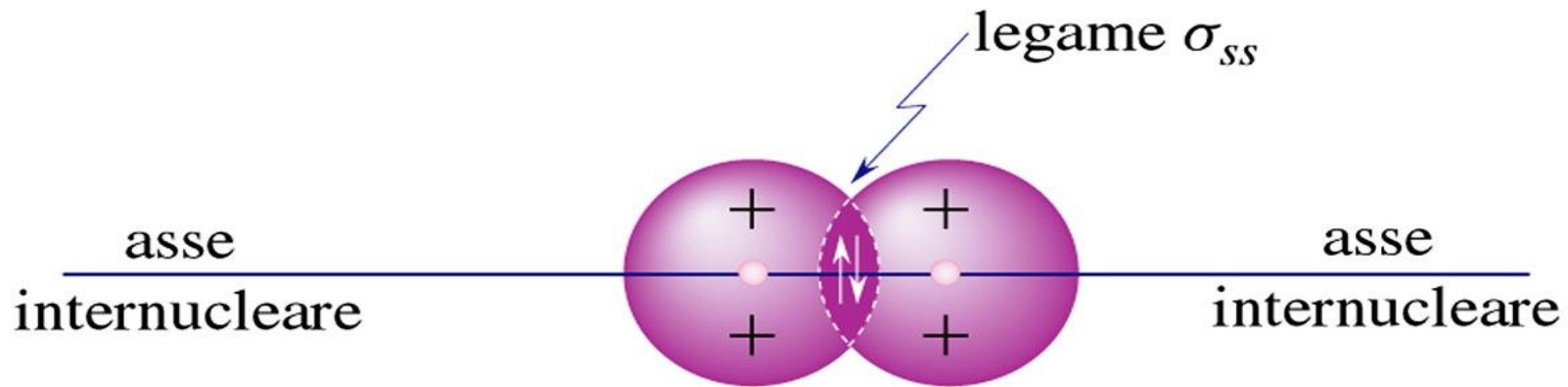

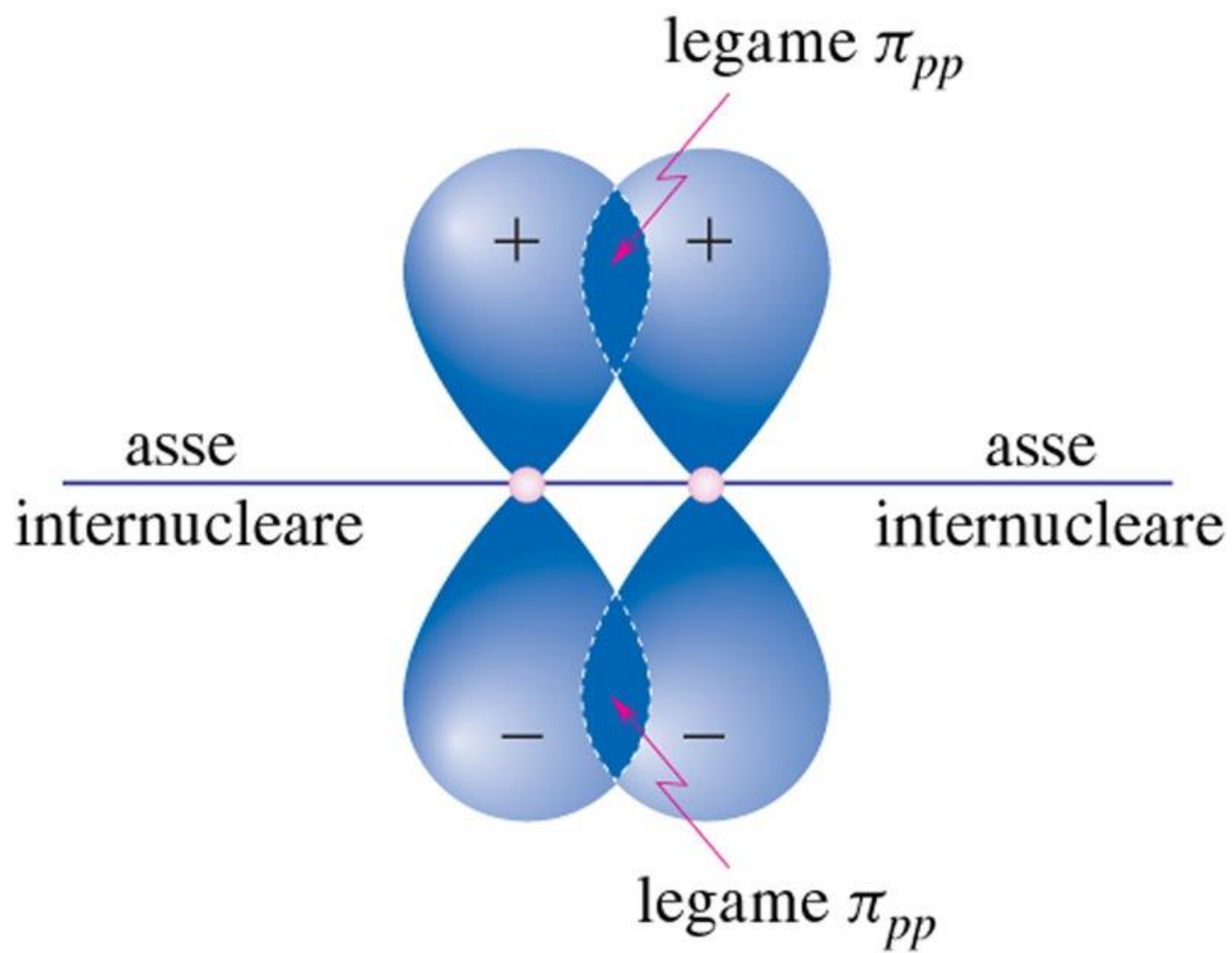

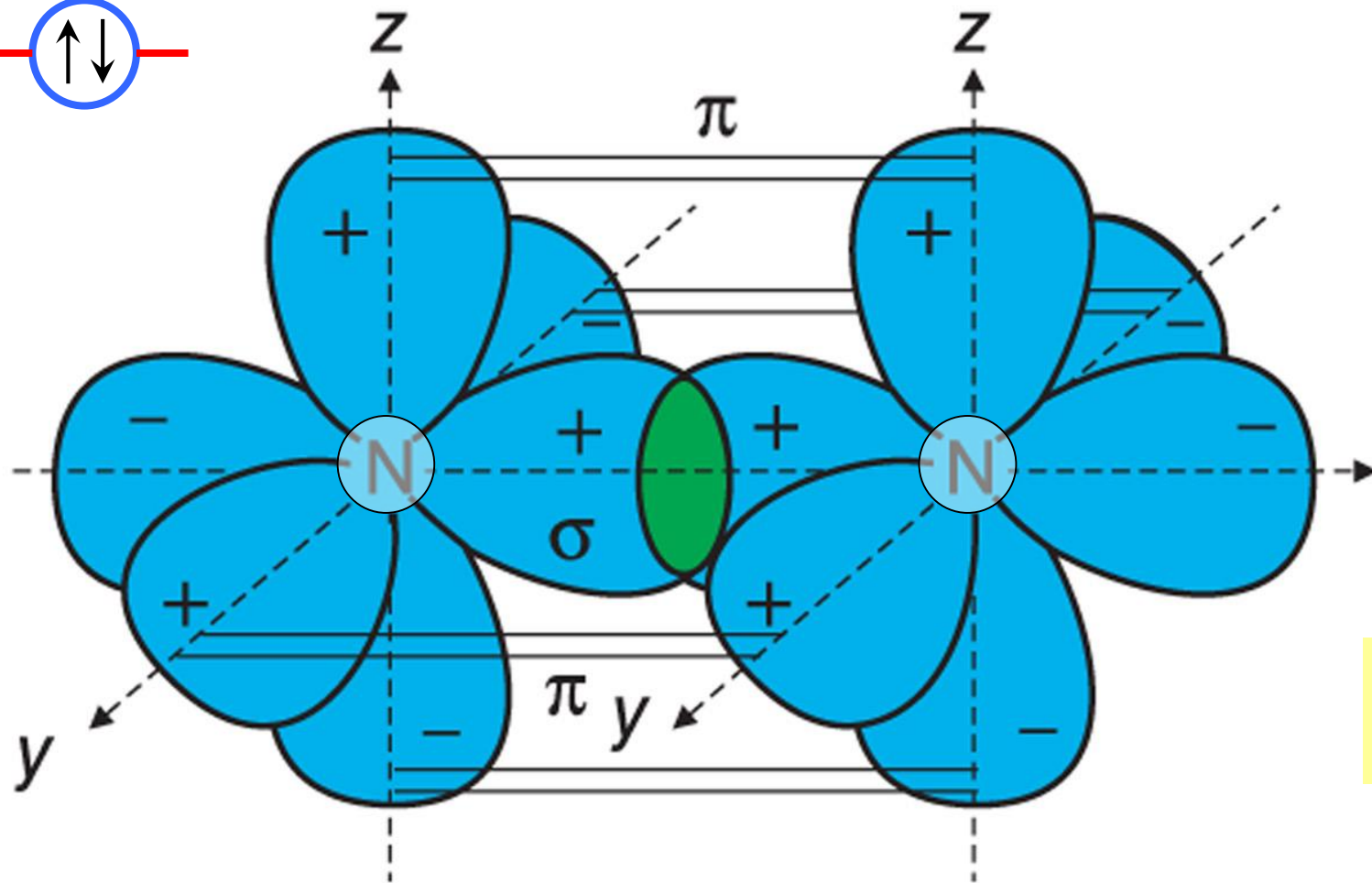
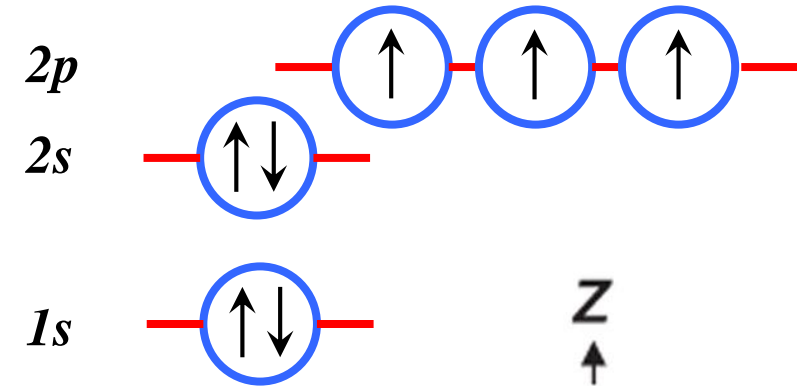
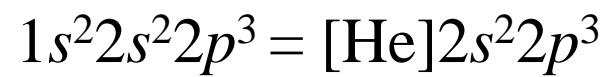

Risonanza

O₃

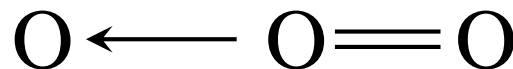
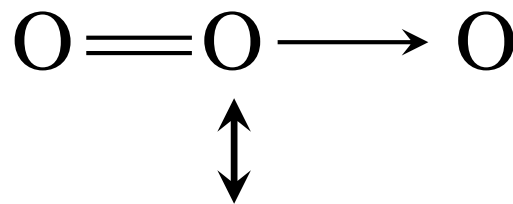
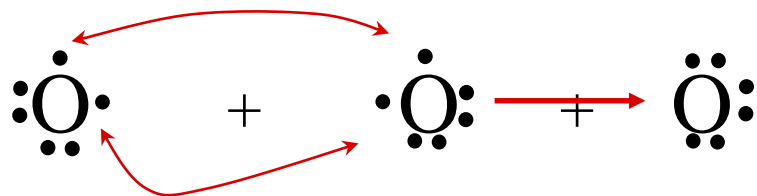

	<i>d</i>
O—O	147 pm
O=O	121 pm
in O ₃	128 pm

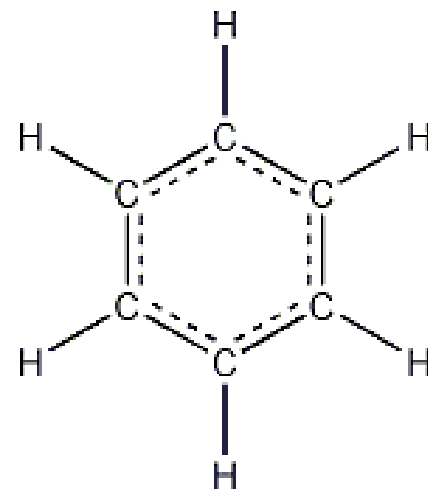
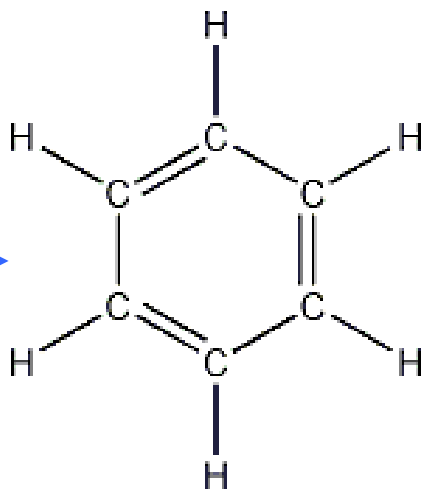
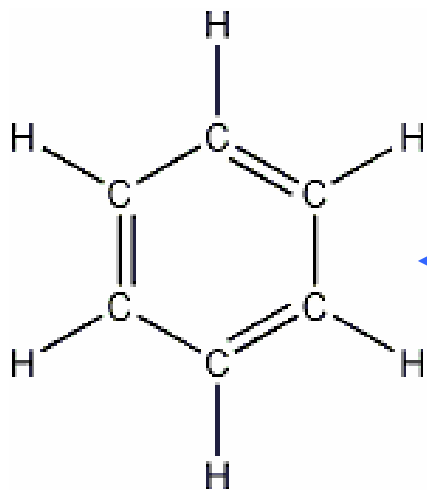

Con la VB il concetto di risonanza viene esteso considerando il legame descritto con più funzioni d'onda

$$\Psi = c_1 \cdot \Psi_{cov}(A-B) + c_2 \cdot \Psi_{ion}(A^+B^-) + c_3 \cdot \Psi_{ion}(A^-B^+)$$

Tanto più sono le forme di risonanza tanto più forte sarà il legame

Geometria Molecolare - VB

L'ibridazione o ibridizzazione è un procedimento di combinazione matematica di un certo numero di orbitali atomici di tipo diverso (*orbitali s, p, d*) e con contenuto energetico poco diverso (orbitali di valenza) di uno stesso atomo, che permette di ottenere nuovi orbitali ibridi equivalenti (*isoenergetici*) con lobi orientati lungo la direzione dei possibili legami.

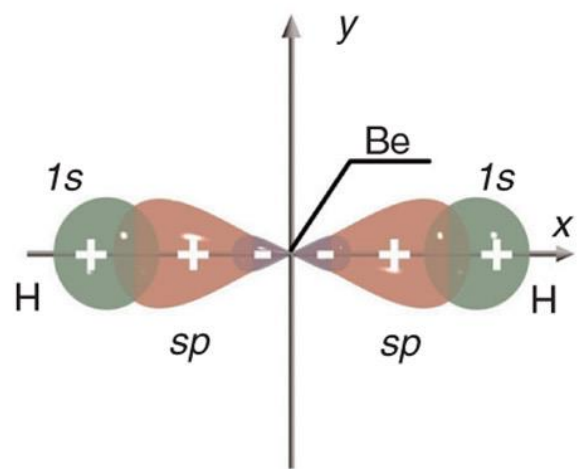
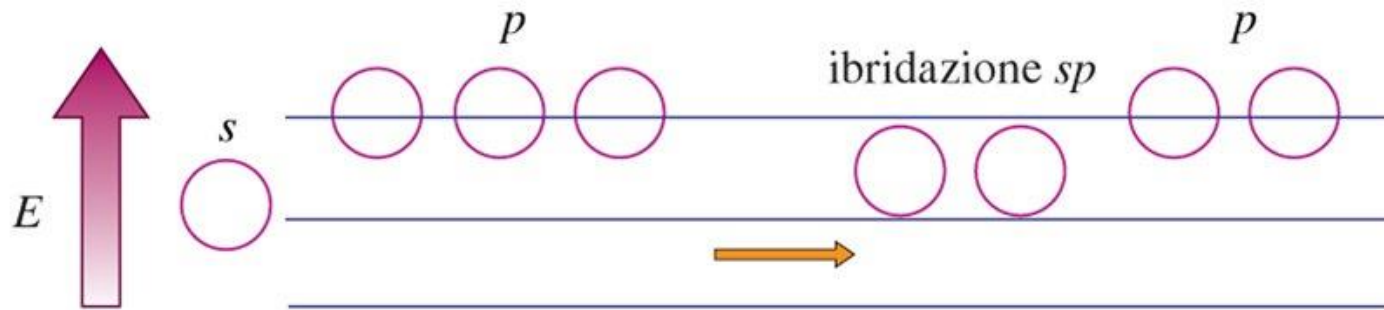

BeH₂

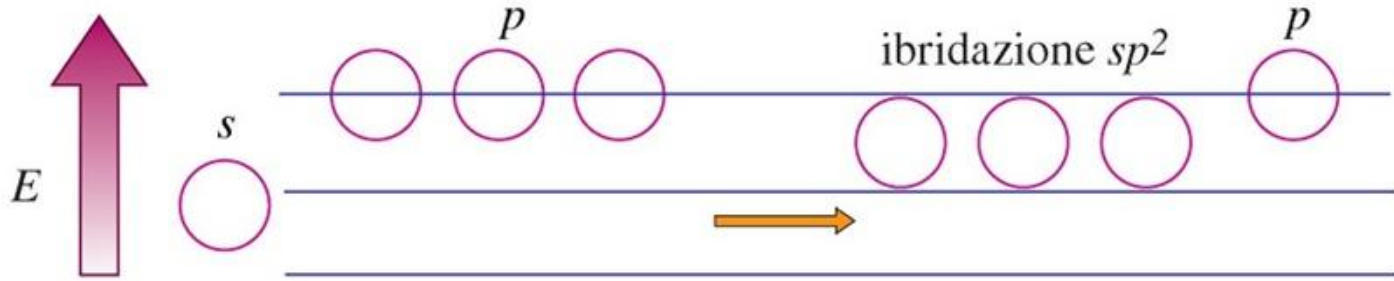

C₂H₄

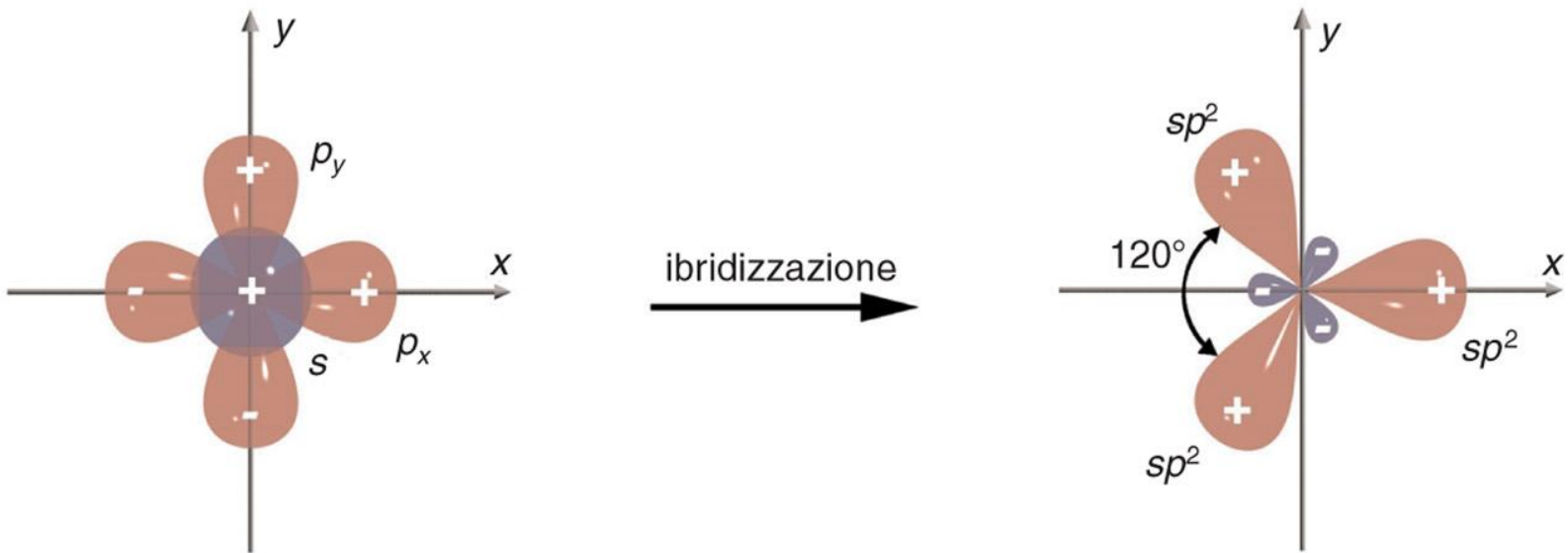

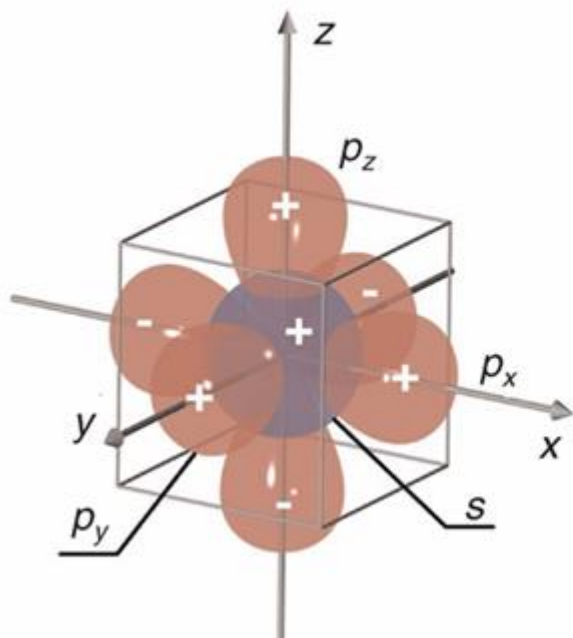
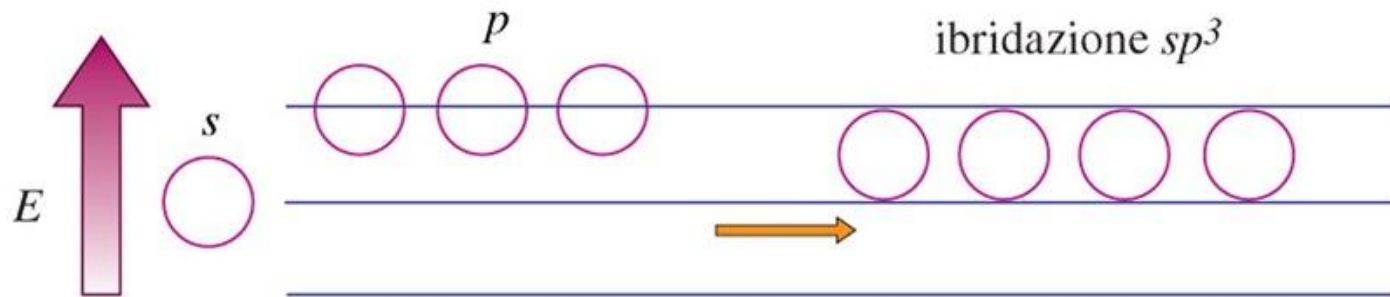

ibridizzazione

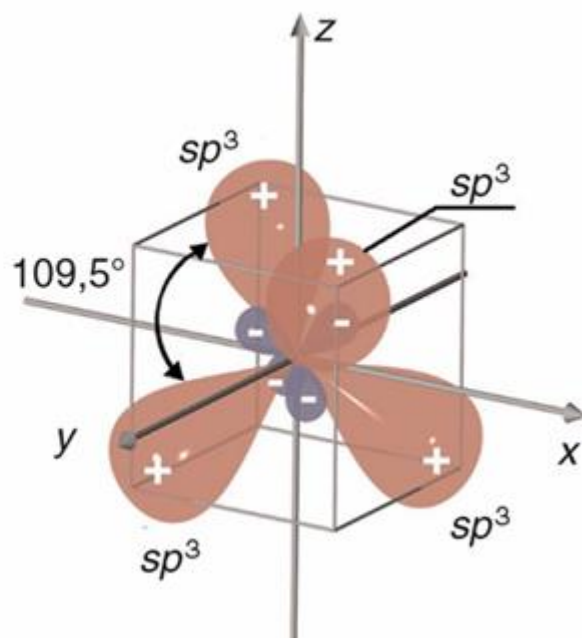

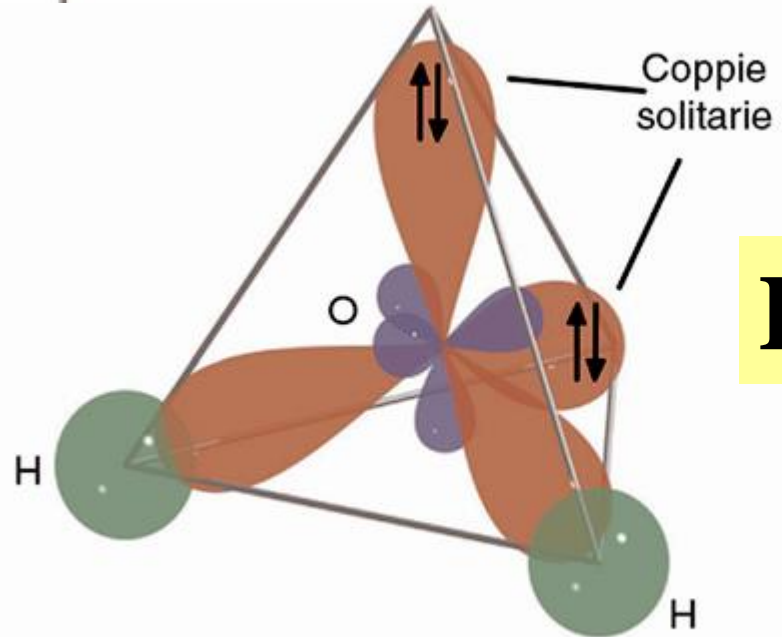
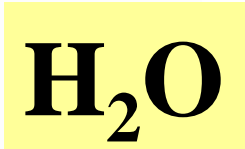
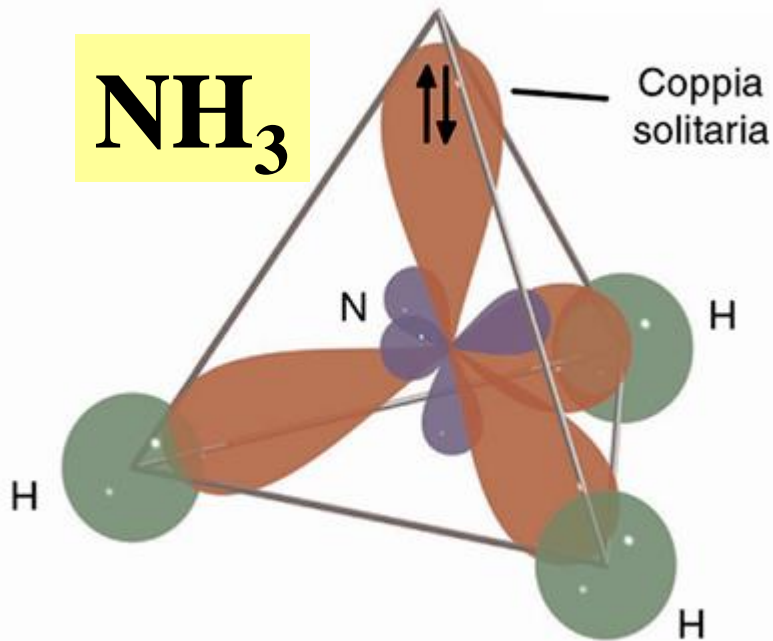
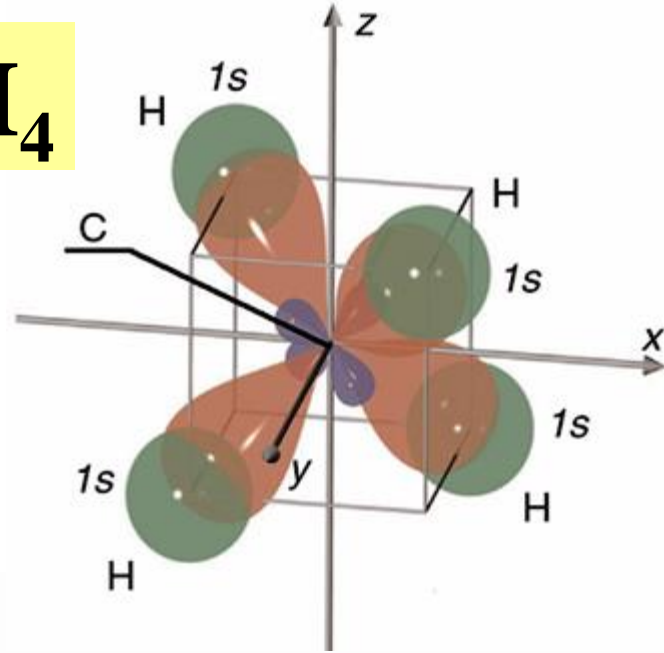

sp^3d

bipiramide trigonale

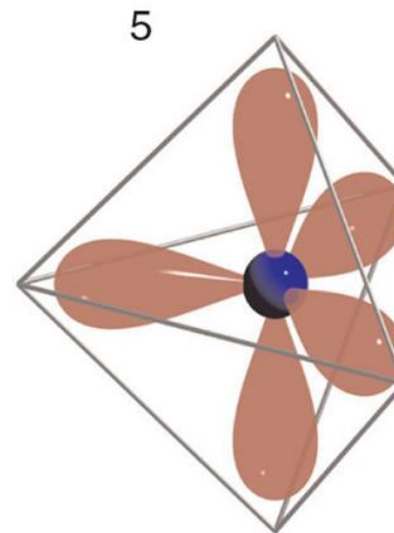

Bipiramidale
trigonale

sp^3d^2

ottaedrica

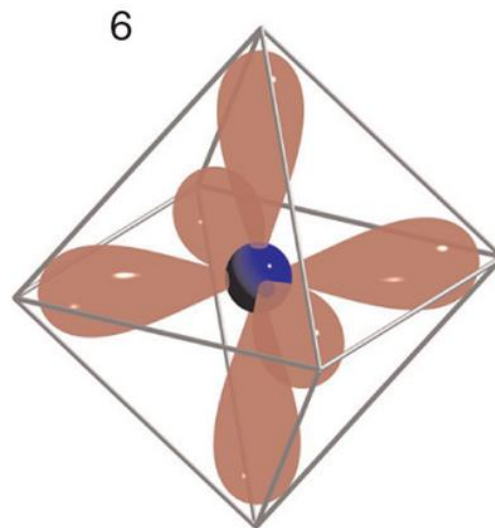

Ottaedrica

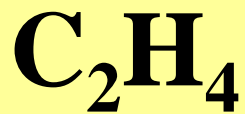

etilene

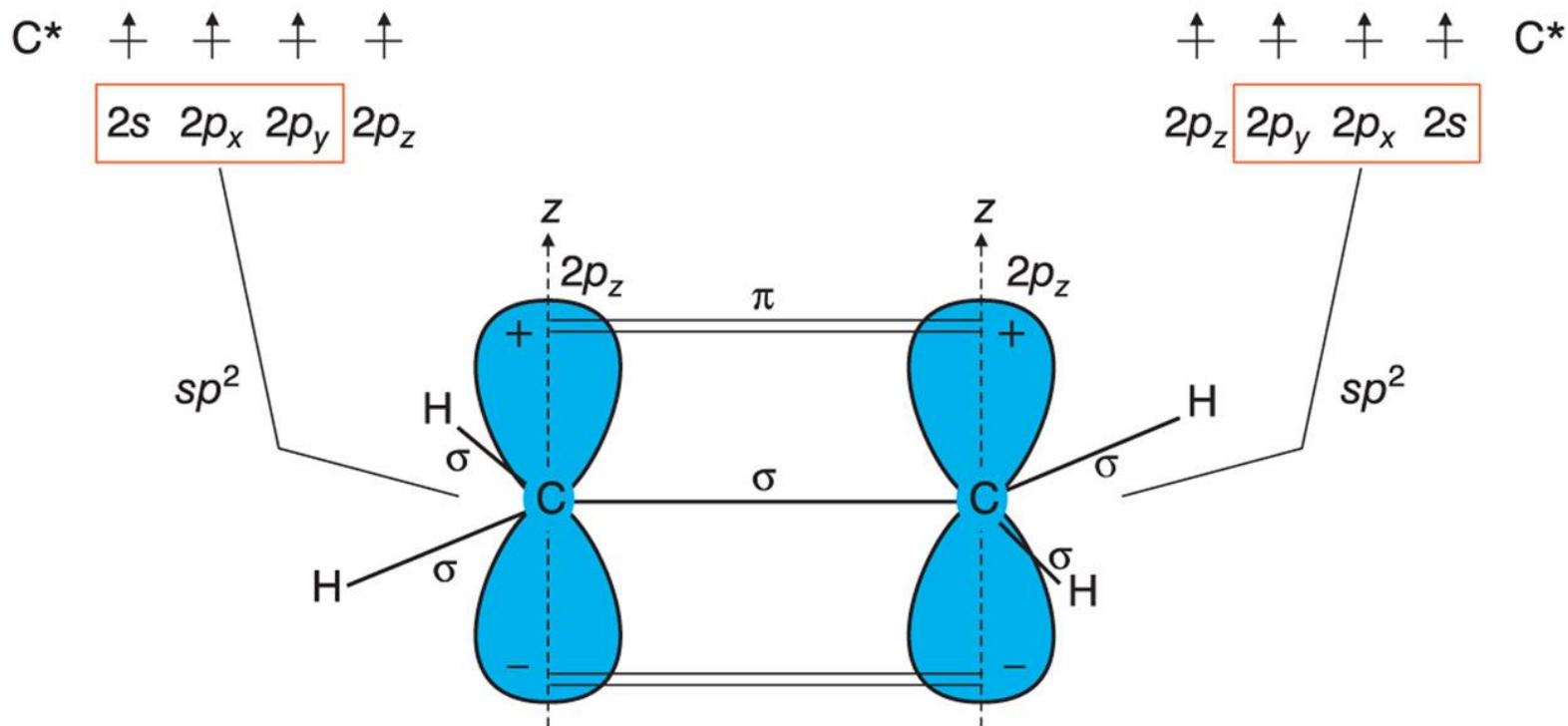

$d(\text{C}=\text{C}) = 134 \text{ pm}$ $E(\text{C}=\text{C}) = 611 \text{ kJ/mol}$
 $d(\text{C}-\text{C}) = 154 \text{ pm}$ $E(\text{C}-\text{C}) = 347 \text{ kJ/mol}$

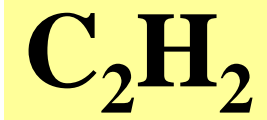

acetilene

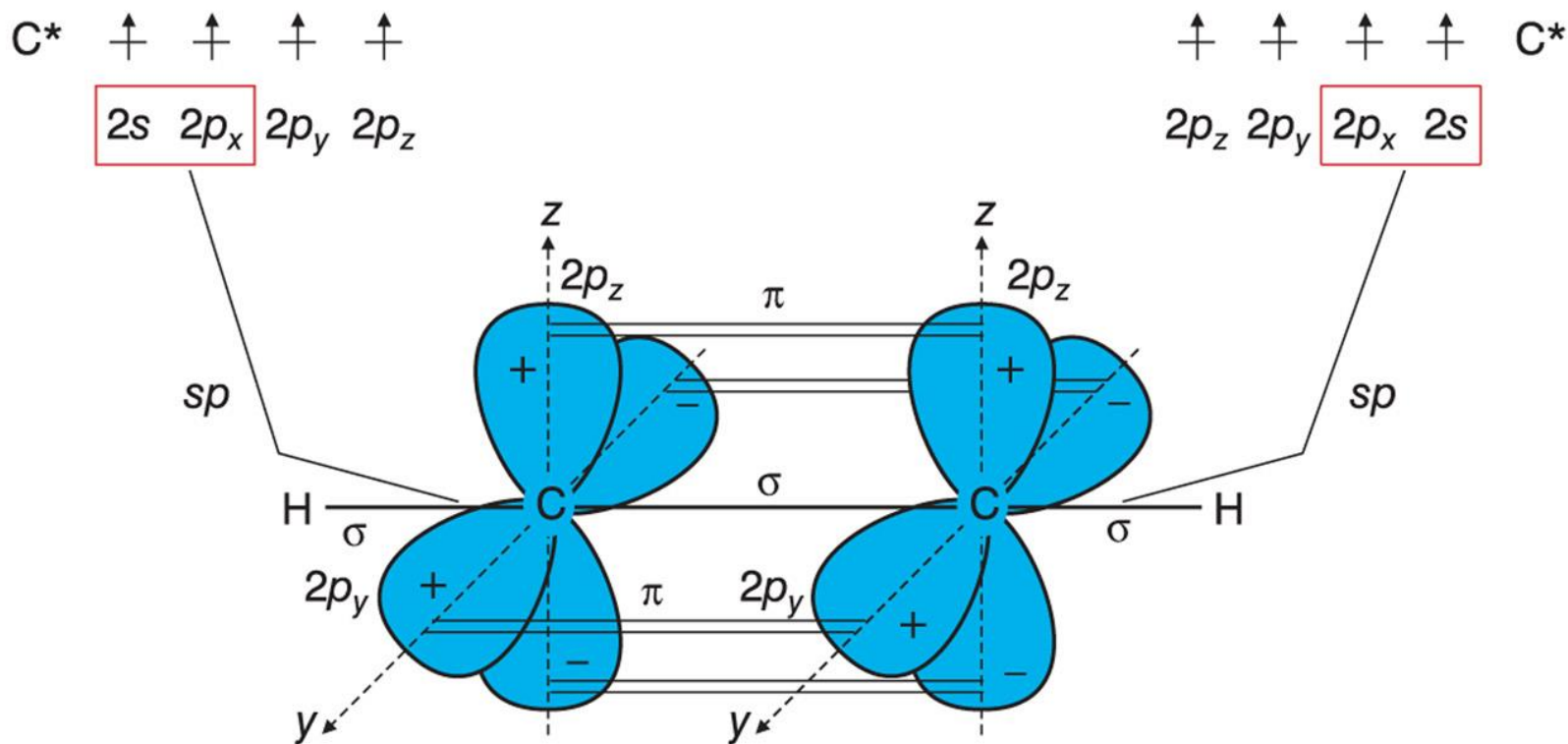

$$d(\text{C}\equiv\text{C}) = 121\text{pm} \quad E(\text{C}\equiv\text{C}) = 830\text{ kJ/mol}$$

Teoria dell'Orbitale Molecolare (MO)

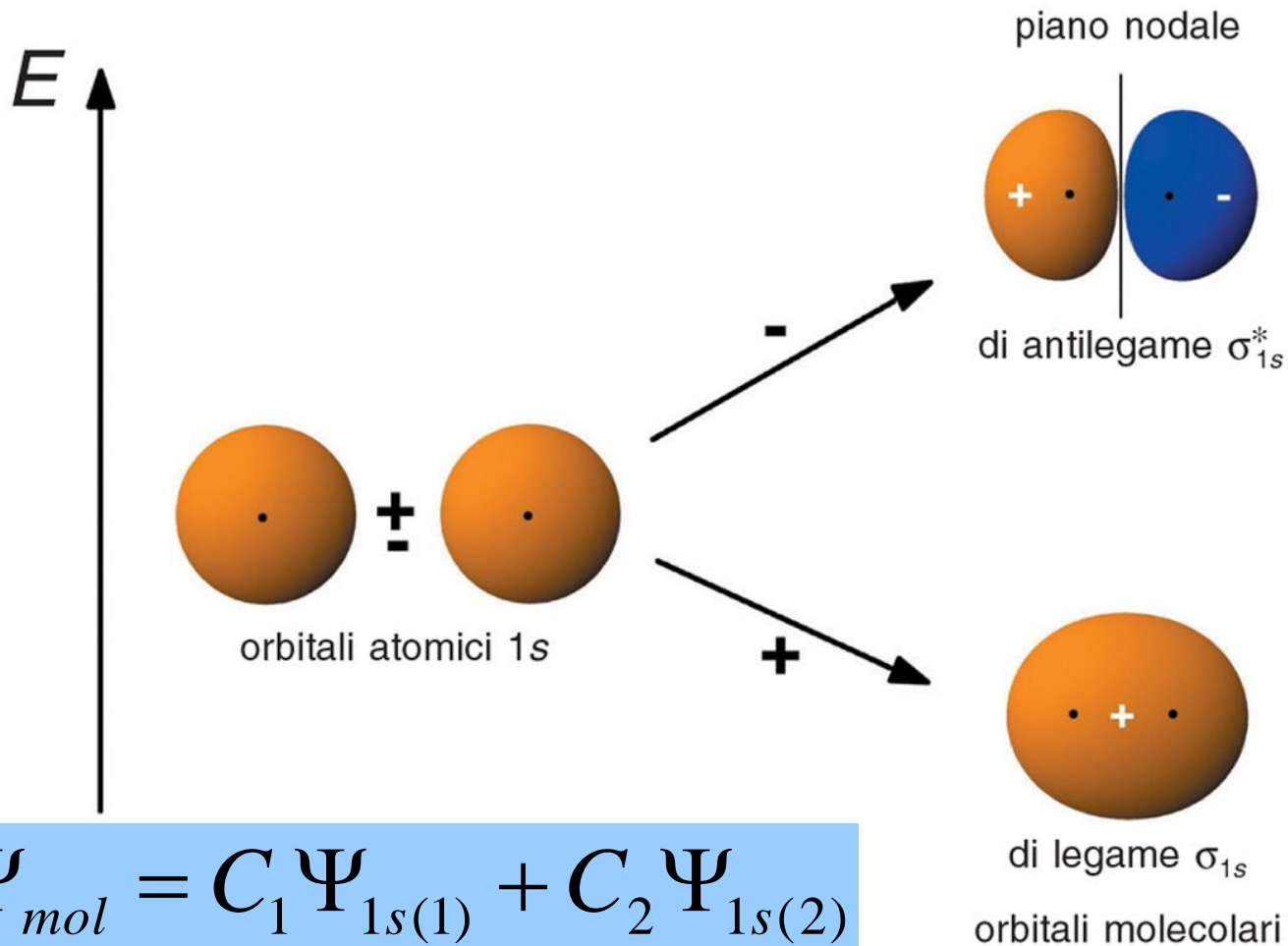

$$\Psi_{mol} = C_1 \Psi_{1s(1)} + C_2 \Psi_{1s(2)}$$

$$C_2 = \pm C_1 \quad ; \quad C_1 = 1$$

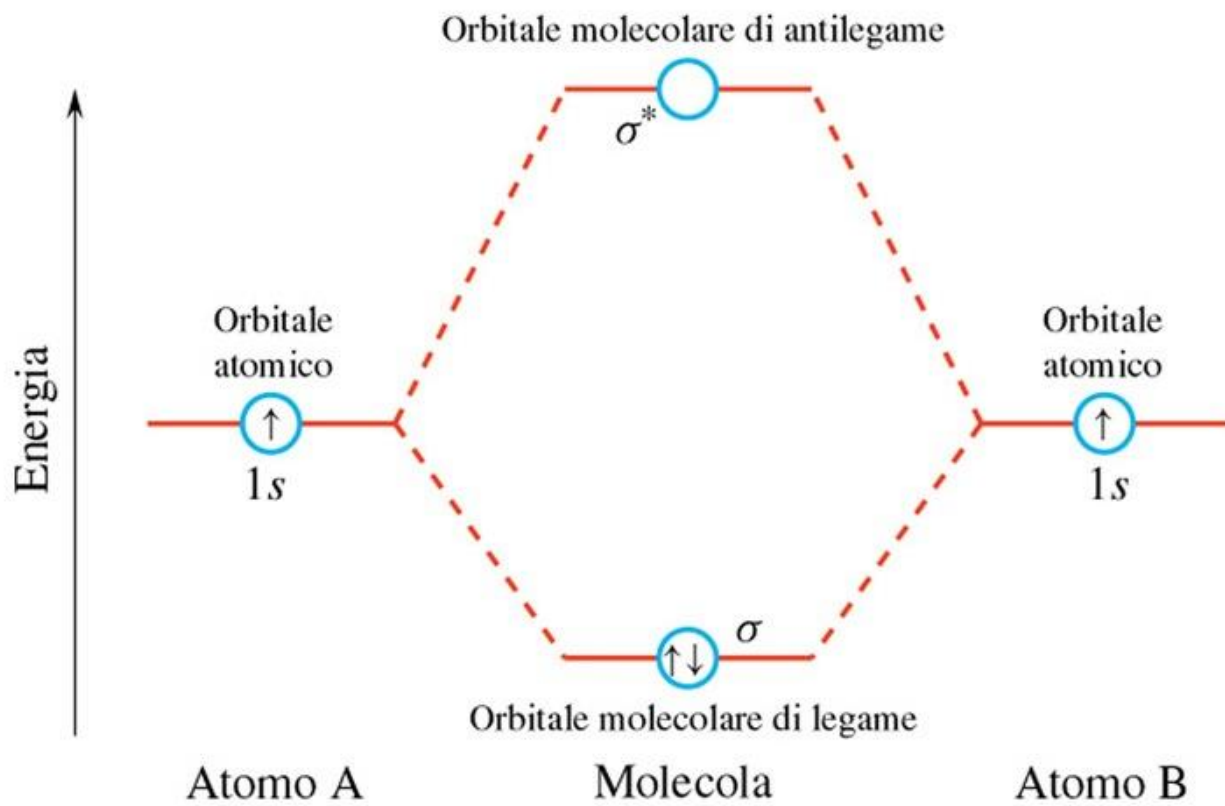

(a)

Molecola	Configurazione elettronica	Ordine di legame distanza (pm) ed energia di legame (kJmol ⁻¹)	Proprietà
H ₂ ⁻¹	(σ _{1s}) ² (σ _{1s} [*]) ¹	$\frac{1}{2}$, esiste ma è instabile <i>d</i> = 106, <i>E</i> = 255	Paramagnetica
H ₂	(σ _{1s}) ²	1, molto stabile <i>d</i> = 74, <i>E</i> = 436	Diamagnetica
He ₂ ⁺	(σ _{1s}) ² (σ _{1s} [*]) ¹	$\frac{1}{2}$, esiste ma è instabile <i>d</i> = 108, <i>E</i> = 251	Paramagnetica
He ₂	(σ _{1s}) ² (σ _{1s} [*]) ²	0	Non esiste

Configurazioni elettroniche di molecole omonucleari formate da elementi del 1° periodo.

E ↑

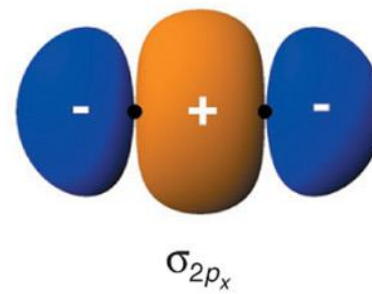
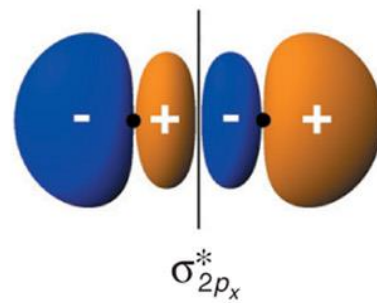
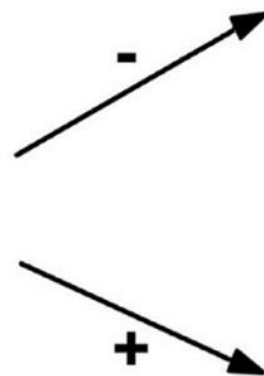
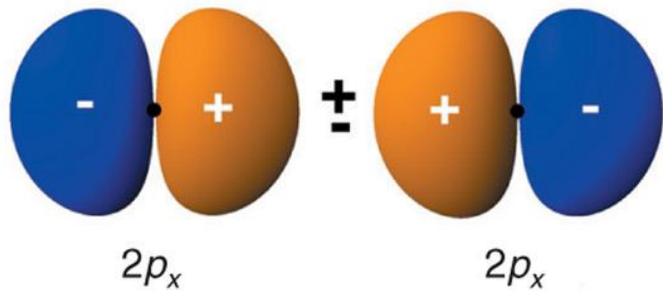

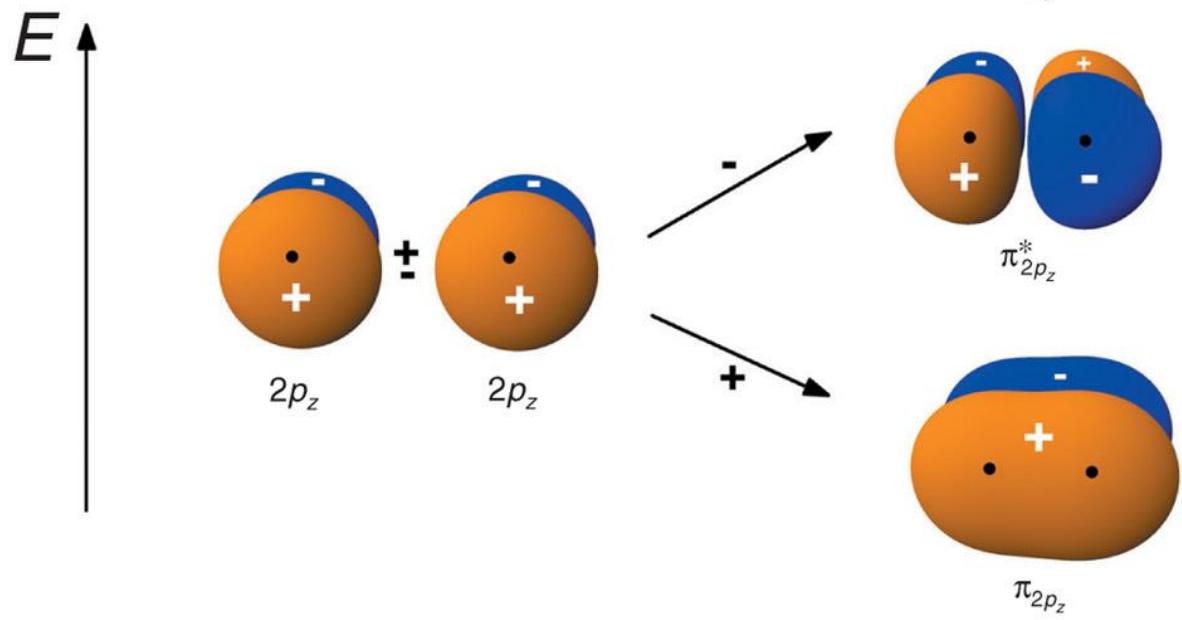
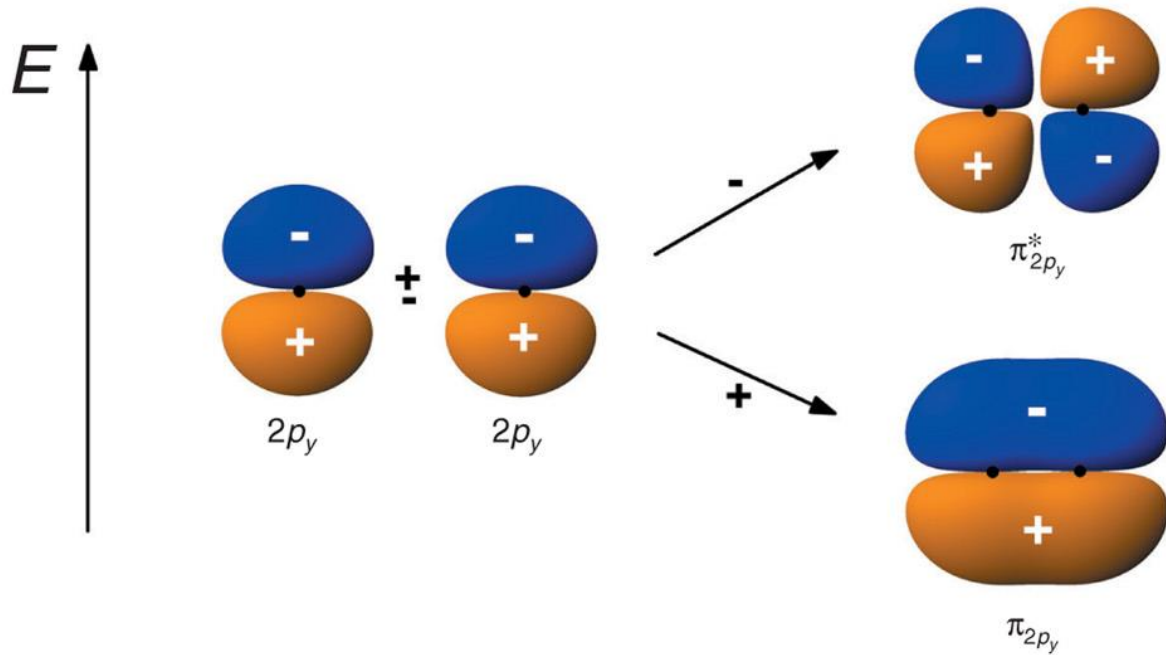

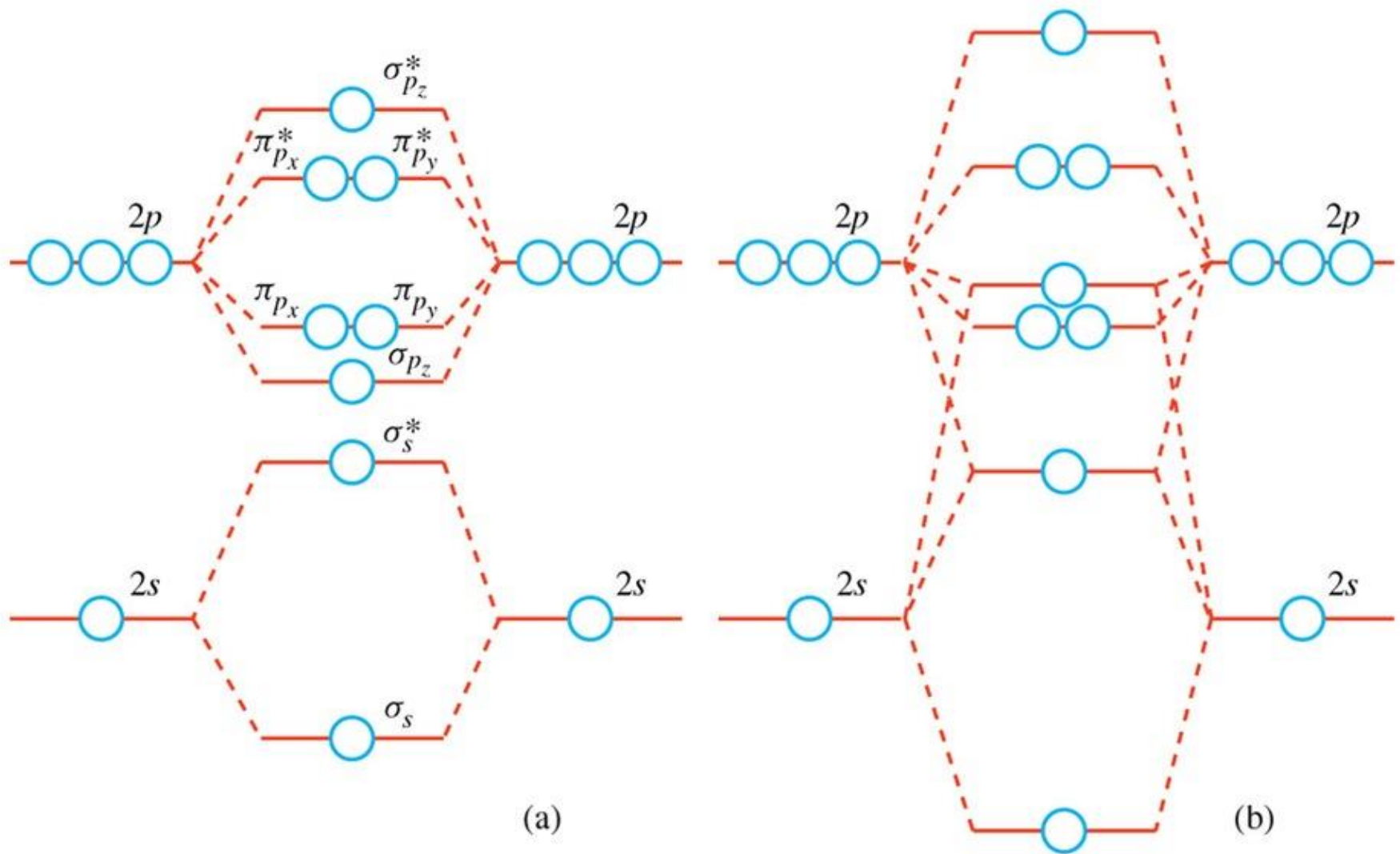

(a)

(b)

Ordine di Legame = differenza tra n° di elettroni negli orbitali di legame e n° di elettroni negli orbitali di antilegame diviso 2

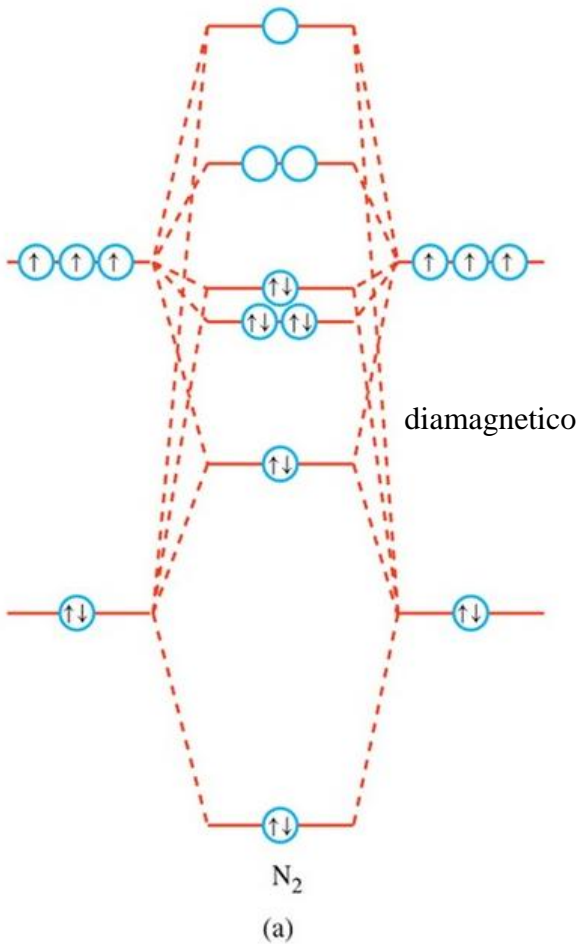

8 legame
2 antilegame

Triplo

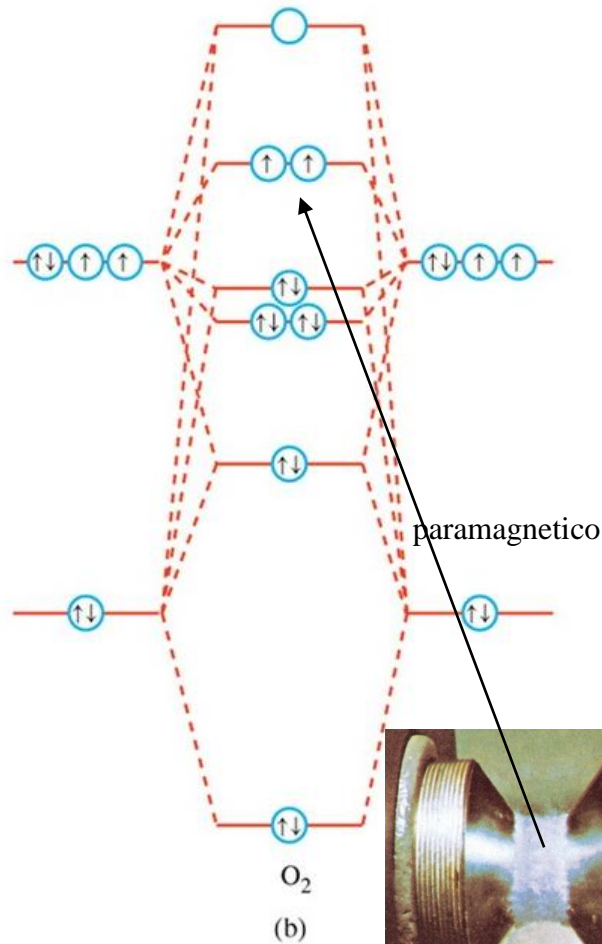

8 legame
4 antilegame

Doppio

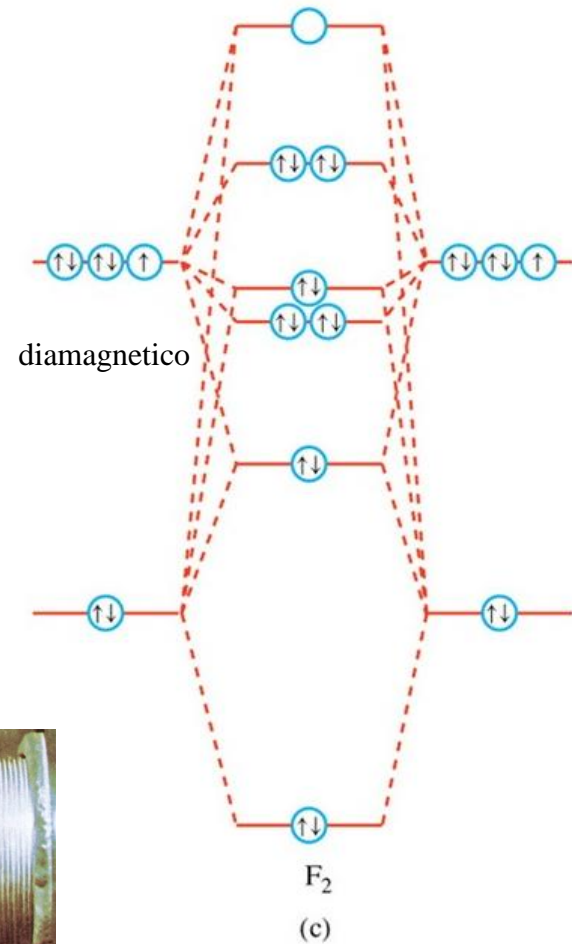
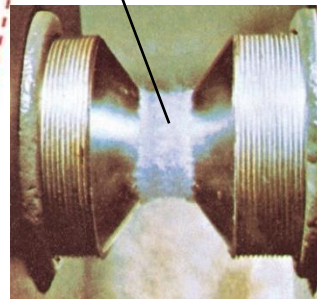

8 legame
6 antilegame

Singolo

Carattere del Legame Chimico

1. Legame Metallico

2. Legame Ionico

3. Legame Covalente

- Omeopolare
- Eteropolare
- Dativo

-DEBOLI-

4. Legame Dipolare

- dipolo - dipolo
- dipolo - dipolo indotto
- dipolo indotto - dipolo indotto

5. Legame Idrogeno

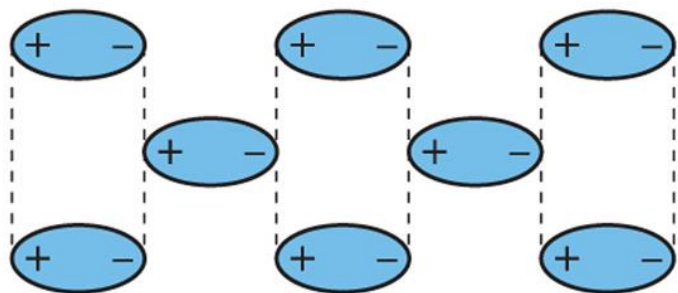

Allineamento di molecole polari

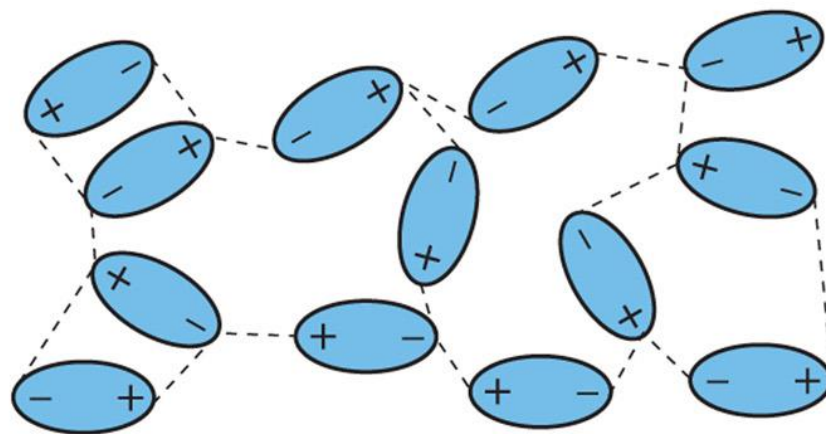

Disposizione più perturbata
di molecole polari

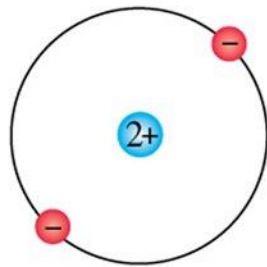

$$\mu = 0$$

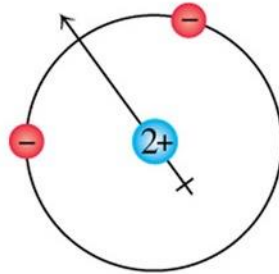

$$\mu \neq 0$$

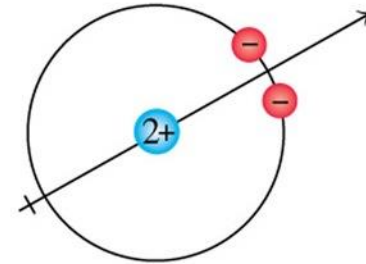

$$\mu \neq 0$$

L'induzione dipolare è tanto più forte tanto più grande è la *polarizzabilità*

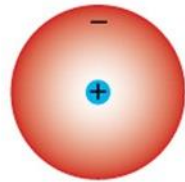

(a)

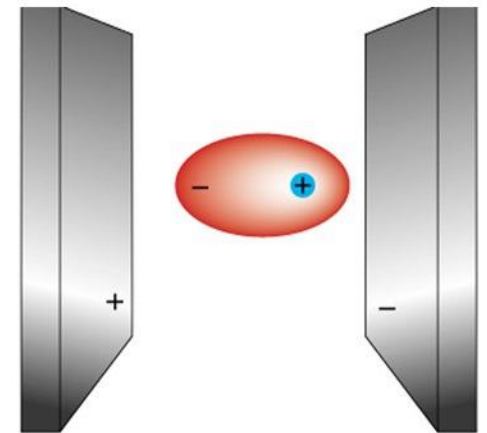

(b)

Molecola con
dipolo permanente

Molecola
apolare

Condizione iniziale

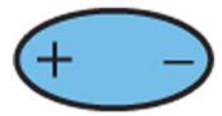

$\mu_1 \neq 0$



$\mu_2 = 0$

Condizione di induzione

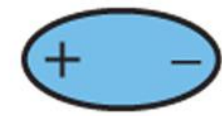

$\mu_1 \neq 0$

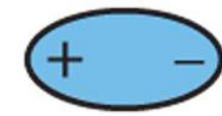

$\mu_2 \neq 0$

Molecola
apolare

Molecola
apolare

Condizione
iniziale

Condizione
istantanea



$\mu = 0$

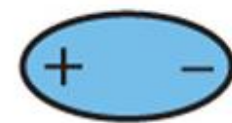

$\mu \neq 0$

Condizione di
interazione

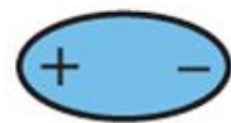

$\mu \neq 0$

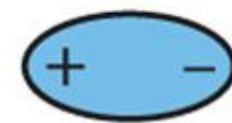





$\mu \neq 0$

Forze di *van der Waals*

$$E = -\frac{C}{r^6}$$

2,4 kJ/mol energia cinetica media a T ambiente (25 °C)

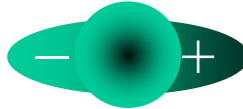
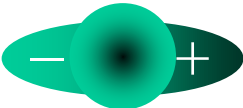
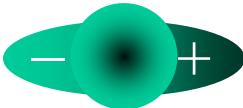
		kJ/mol
Ione 	Dipolo 	40 - 600
Dipolo 	Dipolo 	5 - 25
Incluso il legame Idrogeno		
Dipolo 	Dipolo-indotto 	2 - 10
Dipolo-indotto 	Dipolo-indotto 	0.05 - 40

1 1 H 1.01																	18 2 He 4.00
3 Li 6.94	4 Be 9.01											7 N 14.01	8 O 15.99	9 F 19.00	10 Ne 20.18		
11 Na 22.99	12 Mg 25.31											15 P 30.97	16 S 32.07	17 Cl 35.45	18 Ar 39.95		
19 K 39.10	20 Ca 40.08	21 Sc 44.96	22 Ti 47.87	23 V 50.94	24 Cr 52.00	25 Mn 54.94	26 Fe 55.85	27 Co 58.93	28 Ni 58.71	29 Cu 63.55	30 Zn 65.41	31 Ga 69.72	32 Ge 72.64	33 As 74.92	34 Se 78.96	35 Br 79.90	36 Kr 83.80
37 Rb 85.47	38 Sr 87.62	39 Y 88.91	40 Zr 91.22	41 Nb 92.91	42 Mo 95.94	43 Tc (98)	44 Ru 101.07	45 Rh 101.07	46 Pd 106.42	47 Ag 107.87	48 Cd 112.41	49 In 114.82	50 Sn 118.71	51 Sb 121.76	52 Te 127.60	53 I 126.90	54 Xe 131.29
55 Cs 132.91	56 Ba 137.33	57 La 138.91	72 Hf 178.49	73 Ta 180.95	74 W 183.84	75 Re 186.21	76 Os 190.23	77 Ir 192.22	78 Pt 195.08	79 Au 196.97	80 Hg 200.59	81 Tl 204.38	82 Pb 207.2	83 Bi 208.98	84 Po (209)	85 At (210)	86 Rn (222)
87 Fr (223)	88 Ra (226)	89 Ac (227)	104 Rf (261)	105 Db (262)	106 Sg (266)	107 Bh (264)	108 Hs (270)	109 Mt (268)	110 Ds (281)	111 Rg (272)							



58 Ce 140.12	59 Pr 140.91	60 Nd 144.24	61 Pm (145)	62 Sm 150.36	63 Eu 151.97	64 Gd 157.25	65 Tb 158.93	66 Dy 162.50	67 Ho 164.93	68 Er 167.26	69 Tm 168.93	70 Yb 173.04	71 Lu 174.97
90 Th 232.04	91 Pa 231.04	92 U 238.03	93 Np (237)	94 Pu (244)	95 Am (243)	96 Cm (247)	97 Bk (247)	98 Cf (251)	99 Es (252)	100 Fm (257)	101 Md (258)	102 No (259)	103 Lr (262)

Legame Idrogeno



X e Y = F, O, N e Cl

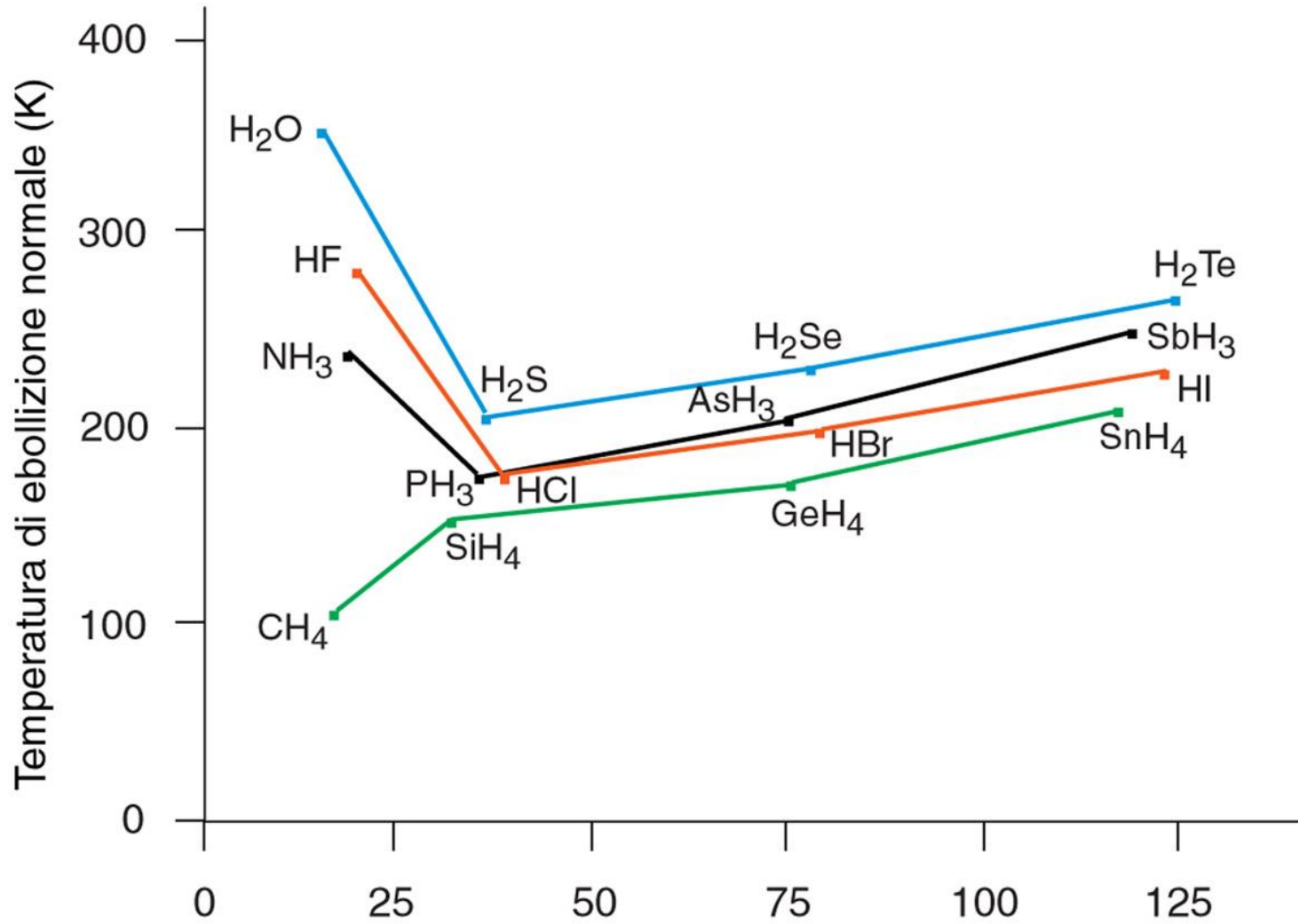

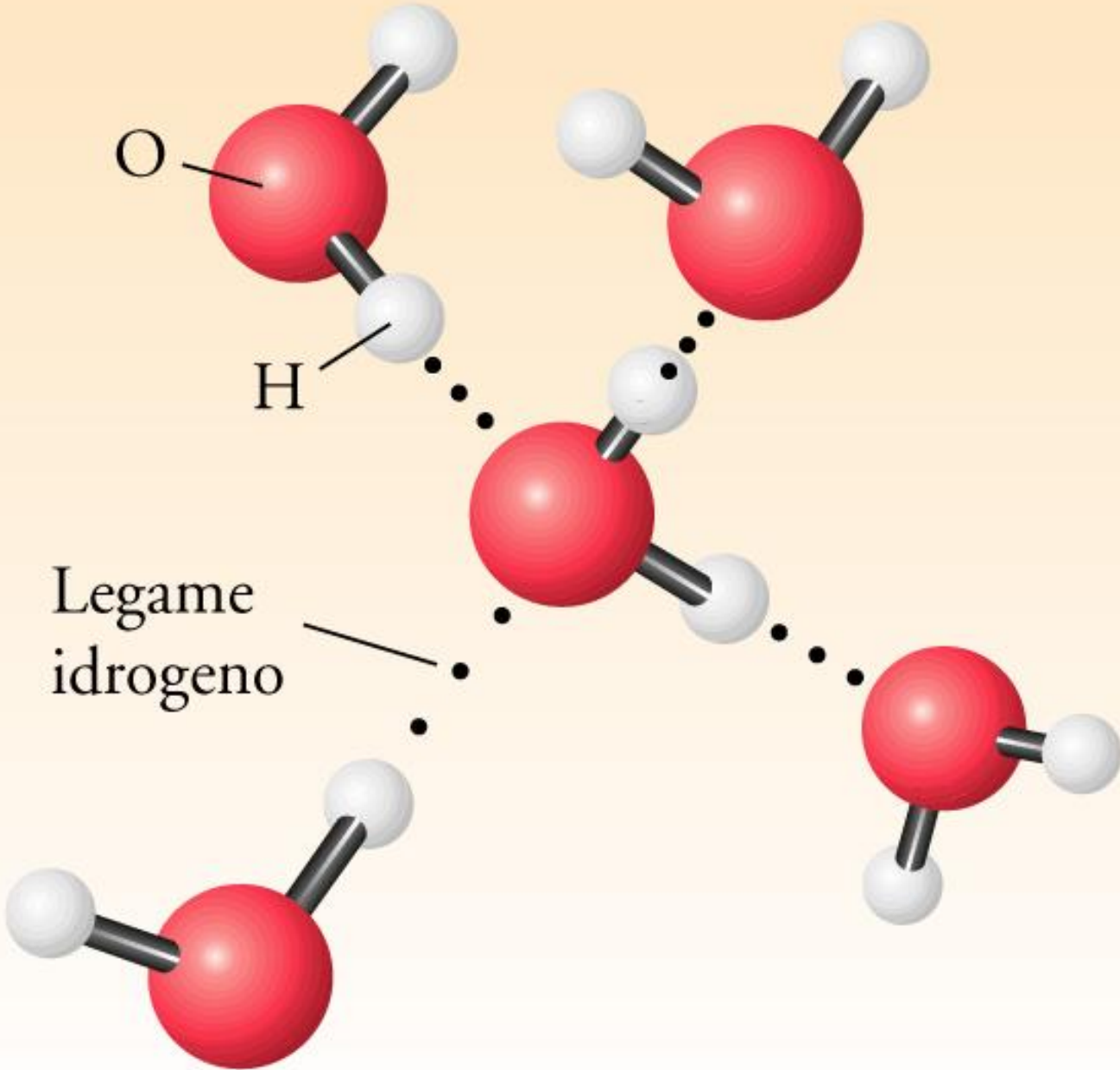



legame idrogeno in HF

